

# 8

## KNIVES, SPARE PARTS, ACCESSORIES



Reversible knives

258



Grooving knives

271



Planing knives

273

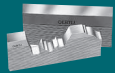

Knife blanks

280



Spacers, Sleeves, Ball bearings, Guide collars

282



Screws, Torque wrenches, Keys

287

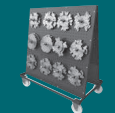

Handling, Measurement, Cleaning

291

**KNIVES, SPARE PARTS, ACCESSORIES**

REVERSIBLE KNIVES>GROOVING KNIVES>PLANING KNIVES>KNIFE BLANKS>SPACERS, SLEEVES, BALL BEARINGS, GUIDE COLLARS>SCREWS, TORQUE WRENCHES, KEYS>HANDLING, MEASUREMENT, CLEANING

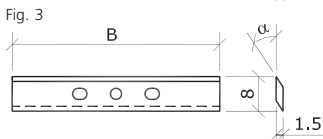
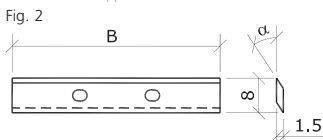
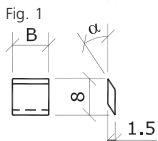
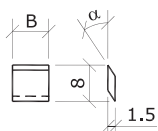
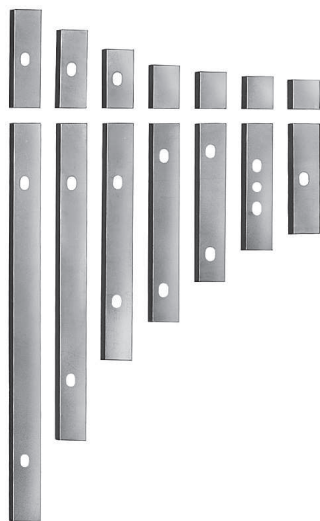

Fig. 4

## Reversible knives OERTLI, straight

**Design:** Packing unit 12 pieces

**Tungsten carbide quality H8, wedge angle 50°**

Art. Nr.	B	h	a	Qual.	Fig.
217008	8	8	1.5	HW	1
217009	9	8	1.5	HW	1
217010	10	8	1.5	HW	2
217011	11	8	1.5	HW	2
217012	12	8	1.5	HW	2
217015	15	8	1.5	HW	2
217020	20	8	1.5	HW	2
217025	25	8	1.5	HW	2
217028	28	8	1.5	HW	2
217030	32	8	1.5	HW	3
217035	32	8	1.5	HW	4
217040	40	8	1.5	HW	3
217050	50	8	1.5	HW	3
217060	60	8	1.5	HW	3
217080	80	8	1.5	HW	3
217099	100	8	1.5	HW	3

**Tungsten carbide quality H6, wedge angle 50°**

Art. Nr.	B	h	a	Qual.	Fig.
217012H6	12	8	1.5	HW	2
217015H6	15	8	1.5	HW	2
217020H6	20	8	1.5	HW	2
217025H6	25	8	1.5	HW	2
217030H6	32	8	1.5	HW	3
217040H6	40	8	1.5	HW	3
217050H6	50	8	1.5	HW	3
217060H6	60	8	1.5	HW	3
217080H6	80	8	1.5	HW	3
217099H6	100	8	1.5	HW	3

**Tungsten carbide quality ECOline, wedge angle 50°**

Art. Nr.	B	h	a	Qual.	Fig.
217615	15	8	1.5	HW	2
217620	20	8	1.5	HW	2
217625	25	8	1.5	HW	2
217635	32	8	1.5	HW	4
217640	40	8	1.5	HW	3
217650	50	8	1.5	HW	3
217660	60	8	1.5	HW	3
217680	80	8	1.5	HW	3
217699	100	8	1.5	HW	3

**Tungsten carbide quality H6, wedge angle 60°**

Art. Nr.	B	h	a	Qual.	Fig.
217209H6	9	8	1.5	HW	1
217215H6	15	8	1.5	HW	2
217220H6	20	8	1.5	HW	2
217225H6	25	8	1.5	HW	2
217235H6	32	8	1.5	HW	4
217240H6	40	8	1.5	HW	3
217250H6	50	8	1.5	HW	3
217260H6	60	8	1.5	HW	3
217280H6	80	8	1.5	HW	3
217299H6	100	8	1.5	HW	3

**KNIVES, SPARE PARTS, ACCESSORIES**

REVERSIBLE KNIVES>GROOVING KNIVES>PLANING KNIVES>KNIFE BLANKS>SPACERS, SLEEVES, BALL BEARINGS, GUIDE COLLARS>SCREWS, TORQUE WRENCHES, KEYS>HANDLING, MEASUREMENT, CLEANING

**Tungsten carbide quality H8, wedge angle 50°, calibrated to length**

Art. Nr.	B	h	a	Qual.	Fig.
217120	20	8	1.5	HW	2
217130	32	8	1.5	HW	3

**Tungsten carbide quality H8, wedge angle 50°, laterally relieved**

Art. Nr.	B	h	a	Qual.	Fig.
217176	32	8	1.5	HW	5
217178	40	8	1.5	HW	5

**Tungsten carbide quality H8, wedge angle 50°, with bevel 20°**

Art. Nr.	B	h	a	Qual.	Fig.
217021	20	8	1.5	HW	6
217022	20	8	1.5	HW	7
217026	25	8	1.5	HW	6
217027	25	8	1.5	HW	7
217031	32	8	1.5	HW	8
217032	32	8	1.5	HW	9

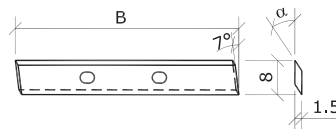

Fig. 5

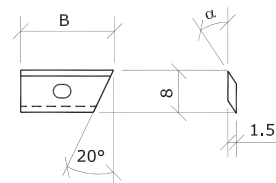

Fig. 6

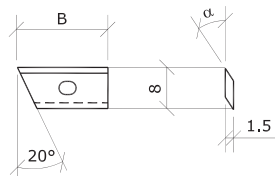

Fig. 7

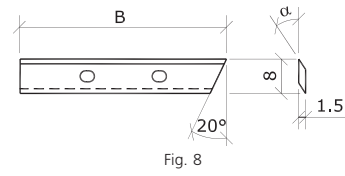

Fig. 8

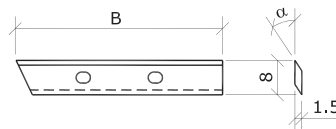

Fig. 9











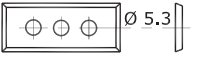
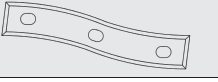



**Reversible knives OERTLI, Format**

**Design:** Packing unit 12 pieces

Art. Nr.	B	h	a	R	α	T max.	Typ	Qual.
216001	17.7	17.7	3.0				Ø 5.7	HW
216008	12.0	12.0	1.5	2.5			Ø 5.4	HW

**KNIVES, SPARE PARTS, ACCESSORIES**

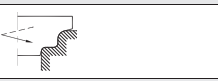
**REVERSIBLE KNIVES>GROOVING KNIVES>PLANING KNIVES>KNIFE BLANKS>SPACERS, SLEEVES, BALL BEARINGS, GUIDE COLLARS>SCREWS, TORQUE WRENCHES, KEYS>HANDLING, MEASUREMENT, CLEANING**

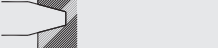
Art. Nr.	B	h	a	R	$\alpha$	T max.	Typ	Qual.	
216013	16.0	16.0	3.0				HW		
216130	42.0	12.0	1.5				HW		
216144	50.0	9.0	1.5				HW		
216162	32.0	8.0	1.5				HW		
216164	32.0	8.0	1.5				HW		
216166	50.0	8.0	1.5				HW		
216168	50.0	8.0	1.5				HW		
216170	15.0	15.0	4.5	7.5			HW		
216306							HW		
216308							HW		
216354	36.5	9.0	1.5				HW		
216002	12.0	12.0	1.5				HW		
216003	12.0	12.0	1.5				HW		
216070	10.0	10.0	4.0	5.0			HW		
216112	50.0	9.0	1.5				HW		
216740							HW		
216741							HW		
216009	14.0	14.0	2.0				HW		
216809							HW		





















**KNIVES, SPARE PARTS, ACCESSORIES**

REVERSIBLE KNIVES>GROOVING KNIVES>PLANING KNIVES>KNIFE BLANKS>SPACERS, SLEEVES, BALL BEARINGS, GUIDE COLLARS>SCREWS, TORQUE WRENCHES, KEYS>HANDLING, MEASUREMENT, CLEANING

Art. Nr.	B	h	a	R	$\alpha$	T max.	Typ	Qual.		
216116	16.6	16.6		2.0				HW		
216118	16.6	16.6		2.0				HW		
216082	9.0	9.0	1.5					HW		
216005	12.0	12.0	1.5					HW		
216186	12.0	12.0	2.0					HW		
216026	7.5	10.0	2.0					HW		
216022	8.8	8.0	1.5					HW		
216007	22.4	22.4	3.5		45°			HW		
216025	23.1	23.1	6.7	1.5				HW		
216010	22.4	22.4	4.5	1.5				HW		
216011	23.8	23.8	5.5	2.5				HW		
216172	4.0	13.0	3.2					HW		
216028	3.7	13.0	3.2				X	HW		
216029	3.7	13.0	3.2				Z	HW		
216564	3.8	14.9						Z	HW	
216566	3.8	14.9						X	HW	
216591	4.8	14.9						Z	HW	
216592	4.8	14.9						X	HW	
216631				1.0				HW		

**KNIVES, SPARE PARTS, ACCESSORIES**

**REVERSIBLE KNIVES>GROOVING KNIVES>PLANING KNIVES>KNIFE BLANKS>SPACERS, SLEEVES, BALL BEARINGS, GUIDE COLLARS>SCREWS, TORQUE WRENCHES, KEYS>HANDLING, MEASUREMENT, CLEANING**

Art. Nr.	B	h	a	R	$\alpha$	T max.	Typ	Qual.	
216632				1.0				HW	
216408	3.8					6.0		HW	
216410	3.8					6.0		HW	
216416				1.0	10°	5.0		HW	
216414				1.0	10°	5.0		HW	
216502				1.0	15°	4.5		HW	
216500				1.0	15°	4.5		HW	
216296				1.0	10°	4.0		HW	
216294				1.0	10°	4.0		HW	
216598	6.0				15°	7.0		HW	
216599	6.0				15°	7.0		HW	
216600				1.0	10°	6.0		HW	
216601				1.0	10°	6.0		HW	
216622				1.5		6.0		HW	
216623				1.5		6.0		HW	
216625	4.0			1.5	15°	4.2		HW	
216626	4.0			1.5	15°	4.2		HW	
216627				2.0 / 1.0	15°	2.5 / 4.0		HW	
216628				2.0 / 1.0	15°	2.5 / 4.0		HW	
216641				3.0	15°	3.0		HW	
216642				3.0	15°	3.0		HW	

**KNIVES, SPARE PARTS, ACCESSORIES**

REVERSIBLE KNIVES>GROOVING KNIVES>PLANING KNIVES>KNIFE BLANKS>SPACERS, SLEEVES, BALL BEARINGS, GUIDE COLLARS>SCREWS, TORQUE WRENCHES, KEYS>HANDLING, MEASUREMENT, CLEANING

Art. Nr.	B	h	a	R	$\alpha$	T max.	Typ	Qual.
216656				2.0	15°	2.5	HW	
216659				1.0	10°	5.0	HW	
216660				1.0	10°	5.0	HW	
216726	3.0			0.5	30°	7.0	HW	
216727	3.0			0.5	30°	7.0	HW	

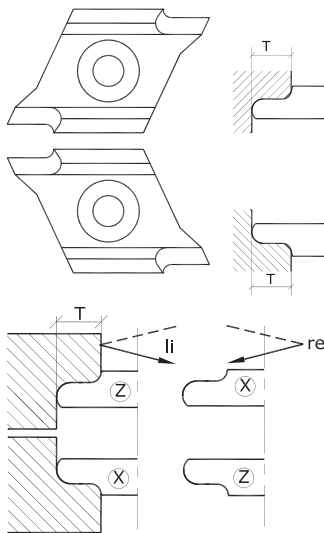

**Reversible knives OERTLI, Format**

Design: Packing unit 12 pieces

Art. Nr.	R	T max.	Typ	Qual.
216380	2.0 / 1.5	7.0	Z	HW
216382	2.0 / 1.5	7.0	X	HW
216510	2.0 / 1.5	8.0	Z	HW
216512	2.0 / 1.5	8.0	X	HW
216569	2.0 / 1.5	9.0	Z	HW
216570	2.0 / 1.5	9.0	X	HW
216384	2.0 / 1.5	10	Z	HW
216386	2.0 / 1.5	10	X	HW
216572	2.0 / 1.5	11	Z	HW
216573	2.0 / 1.5	11	X	HW
216388	2.0 / 1.5	12	Z	HW
216390	2.0 / 1.5	12	X	HW
216655	2.0 / 1.5	13	X	HW
216392	2.0 / 1.5	14	Z	HW
216394	2.0 / 1.5	14	X	HW
216396	2.0 / 1.5	15	Z	HW
216398	2.0 / 1.5	15	X	HW

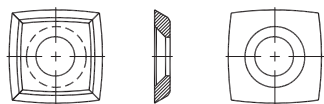

**Reversible knives OERTLI, Format**

Design: Packing unit 12 pieces

Art. Nr.	B	h	a	R	Typ	Qual.
216672	15	15	2.5	50	H8	HW
216672H6	15	15	2.5	50	H6	HW
216571	15	15	2.5	50	ECOline	HW
216665	15	15	2.5	150	CASTOR Classic	HW

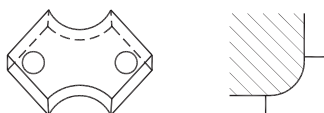

**Reversible knives OERTLI, Format**

Design: Packing unit 12 pieces

Art. Nr.	R	$\alpha$	Qual.
216840	1.5		HW
216031	2.0		HW
216030	3.0		HW
216032	4.0		HW

**KNIVES, SPARE PARTS, ACCESSORIES**

REVERSIBLE KNIVES>GROOVING KNIVES>PLANING KNIVES>KNIFE BLANKS>SPACERS, SLEEVES, BALL BEARINGS, GUIDE COLLARS>SCREWS, TORQUE WRENCHES, KEYS>HANDLING, MEASUREMENT, CLEANING

Art. Nr.	R	$\alpha$	Qual.
216034	5.0		HW
216036	6.0		HW
216507		45°	HW
216038	7.0		HW
216040	8.0		HW
216042	9.0		HW
216044	10		HW
216046	11		HW
216048	12		HW
216049	13		HW
216050	14		HW
216052	15		HW

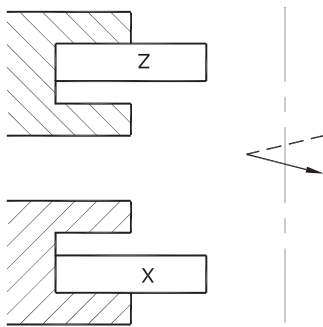

**Reversible knives OERTLI, Format**

**Design:** Packing unit 12 pieces

Art. Nr.	B	h	a	Typ	Qual.
216027	3.7	14.9	3.2		HW
216302	5.0	14.9	3.2	Z	HW
216304	5.0	14.9	3.2	X	HW
216086	5.7	14.9	3.2		HW

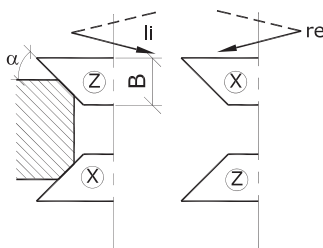

**Reversible knives OERTLI, Format**

**Design:** Packing unit 12 pieces

Art. Nr.	$\alpha$	Typ	B	Qual.
216212	45°	Z	6	HW
216214	45°	X	6	HW
216213	45°	Z	6	HW
216215	45°	X	6	HW
216629	45°	Z	6	HW
216630	45°	X	6	HW

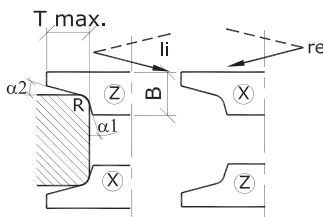

**Reversible knives OERTLI, Format**

**Design:** Packing unit 12 pieces

Art. Nr.	R	Typ	$\alpha1$	$\alpha2$	T max.	B	Qual.
216604	1.0	Z	15°	15°	2.00	6.0	HW
216605	1.0	X	15°	15°	2.00	6.0	HW
216324	1.5	Z	15°	15°	2.00	6.0	HW
216326	1.5	X	15°	15°	2.00	6.0	HW
216150	1.5	Z	15°	15°	6.00	6.0	HW
216152	1.5	X	15°	15°	6.00	6.0	HW
216216	1.5	Z	25°	15°	6.00	6.0	HW
216218	1.5	X	25°	15°	6.00	6.0	HW
216340	1.5	Z	25°	15°	2.00	6.0	HW
216342	1.5	X	25°	15°	2.00	6.0	HW
216696	1.5	Z	15°	15°	3.60	9.5	HW
216697	1.5	X	15°	15°	3.60	9.5	HW



**KNIVES, SPARE PARTS, ACCESSORIES**
**REVERSIBLE KNIVES>GROOVING KNIVES>PLANING KNIVES>KNIFE BLANKS>SPACERS, SLEEVES, BALL BEARINGS, GUIDE COLLARS>SCREWS, TORQUE WRENCHES, KEYS>HANDLING, MEASUREMENT, CLEANING**

Art. Nr.	R	Typ	$\alpha 1$	$\alpha 2$	T max.	B	Qual.
216614	2.0	Z	15°	15°	2.50	6.0	HW
216615	2.0	X	15°	15°	2.50	6.0	HW
216579	2.0	Z	15°	15°	6.00	6.0	HW
216580	2.0	X	15°	15°	6.00	6.0	HW
216581	2.0	Z	35°	15°	2.50	6.0	HW
216582	2.0	X	35°	15°	2.50	6.0	HW
216698	2.0	Z	15°	15°	4.00	9.5	HW
216699	2.0	X	15°	15°	4.00	9.5	HW
216316	2.5	Z	15°	15°	3.00	6.0	HW
216318	2.5	X	15°	15°	3.00	6.0	HW
216426	2.5	Z	15°	25°	3.00	6.0	HW
216428	2.5	X	15°	25°	3.00	6.0	HW
216140	2.5	Z	15°	15°	6.00	6.0	HW
216142	2.5	X	15°	15°	6.00	6.0	HW
216336	2.5	Z	25°	15°	3.00	6.0	HW
216338	2.5	X	25°	15°	3.00	6.0	HW
216188	2.5	Z	25°	15°	6.00	6.0	HW
216190	2.5	X	25°	15°	6.00	6.0	HW
216358	2.5	Z	35°	15°	6.00	6.0	HW
216360	2.5	X	35°	15°	6.00	6.0	HW
216700	2.5	Z	15°	15°	4.35	9.5	HW
216701	2.5	X	15°	15°	4.35	9.5	HW
216712	2.5	Z	25°	15°	4.35	9.5	HW
216713	2.5	X	25°	15°	4.35	9.5	HW
216722	2.5	Z	15°	25°	3.00	9.5	HW
216723	2.5	X	15°	25°	3.00	9.5	HW
216427	3.0	Z	15°	25°	3.50	6.0	HW
216429	3.0	X	15°	25°	3.50	6.0	HW
216637	3.0	Z	15°	15°	6.00	6.0	HW
216638	3.0	X	15°	15°	6.00	6.0	HW
216639	3.0	Z	25°	15°	6.00	6.0	HW
216640	3.0	X	25°	15°	6.00	6.0	HW
216702	3.0	Z	15°	15°	4.72	9.5	HW
216703	3.0	X	15°	15°	4.72	9.5	HW
216714	3.0	Z	25°	15°	4.72	9.5	HW
216715	3.0	X	25°	15°	4.72	9.5	HW
216268	3.5	Z	15°	15°	6.00	8.0	HW
216270	3.5	X	15°	15°	6.00	8.0	HW
216682	4.0	Z	15°	15°	7.00	9.5	HW
216685	4.0	X	15°	15°	7.00	9.5	HW
216692	4.0	Z	25°	15°	7.00	9.5	HW
216693	4.0	X	25°	15°	7.00	9.5	HW
216496	4.0	Z	25°	15°	6.00	8.0	HW
216498	4.0	X	25°	15°	6.00	8.0	HW
216704	4.0	Z	15°	15°	5.46	9.5	HW
216705	4.0	X	15°	15°	5.46	9.5	HW
216716	4.0	Z	25°	15°	5.46	9.5	HW
216717	4.0	X	25°	15°	5.46	9.5	HW
216694	4.0	Z	15°	25°	5.31	9.5	HW
216695	4.0	X	15°	25°	5.31	9.5	HW
216683	5.0	Z	15°	15°	7.00	9.5	HW
216686	5.0	X	15°	15°	7.00	9.5	HW
216706	5.0	Z	15°	15°	6.21	9.5	HW
216707	5.0	X	15°	15°	6.21	9.5	HW
216684	6.0	Z	15°	15°	7.00	9.5	HW
216687	6.0	X	15°	15°	7.00	9.5	HW
216688	6.0	Z	25°	15°	7.00	9.5	HW
216689	6.0	X	25°	15°	7.00	9.5	HW
216690	6.0	Z	15°	25°	7.00	9.5	HW
216691	6.0	X	15°	25°	7.00	9.5	HW
216708	6.0	Z	15°	15°	6.95	9.5	HW

**KNIVES, SPARE PARTS, ACCESSORIES**

REVERSIBLE KNIVES>GROOVING KNIVES>PLANING KNIVES>KNIFE BLANKS>SPACERS, SLEEVES, BALL BEARINGS, GUIDE COLLARS>SCREWS, TORQUE WRENCHES, KEYS>HANDLING, MEASUREMENT, CLEANING

Art. Nr.	R	Typ	$\alpha 1$	$\alpha 2$	T max.	B	Qual.
216709	6.0	X	15°	15°	6.95	9.5	HW
216724	6.0	Z	15°	25°	6.46	9.5	HW
216725	6.0	X	15°	25°	6.46	9.5	HW
216718	6.0	Z	25°	15°	6.95	9.5	HW
216719	6.0	X	25°	15°	6.95	9.5	HW

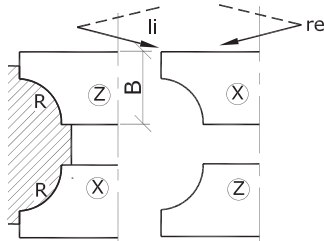

**Reversible knives OERTLI, Format**

Design: Packing unit 12 pieces

Art. Nr.	R	Typ	B	Qual.
216238	2.0	Z	9.5	HW
216240	2.0	X	9.5	HW
216242	3.0	Z	9.5	HW
216244	3.0	X	9.5	HW
216246	4.0	Z	9.5	HW
216248	4.0	X	9.5	HW
216204	5.0	Z	9.5	HW
216206	5.0	X	9.5	HW
216250	6.0	Z	9.5	HW
216252	6.0	X	9.5	HW

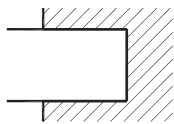

**Reversible knives OERTLI, Format**

Design: Packing unit 12 pieces

Art. Nr.	B	h	R	$\alpha$	T max.	Qual.
216814	3.0	31		0.5x45°	4.0	HW
216817	4.0	31		0.5x45°	6.0	HW
216550	4.0	35	1.0		8.0	HW
216400	6.0	31			7.0	HW
216668	6.0	31			3.2	HW

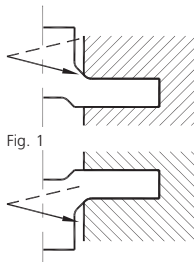

Fig. 2

**Reversible knives OERTLI, Format**

Design: Packing unit 12 pieces

Art. Nr.	B	T max.	Qual.	Fig.
216729	3.0	8.0	HW	1
216728	3.0	8.0	HW	2
216731	4.0	8.0	HW	1
216730	4.0	8.0	HW	2
216733	5.0	8.0	HW	1
216732	5.0	8.0	HW	2

**KNIVES, SPARE PARTS, ACCESSORIES**

REVERSIBLE KNIVES>GROOVING KNIVES>PLANING KNIVES>KNIFE BLANKS>SPACERS, SLEEVES, BALL BEARINGS, GUIDE COLLARS>SCREWS, TORQUE WRENCHES, KEYS>HANDLING, MEASUREMENT, CLEANING

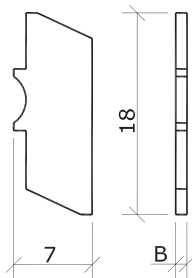

**Shims for four-corner knives**

Art. Nr.	B
851292	0.1
851293	0.2
851294	0.5
851295	1.0
851296	2.0
851297	5.0

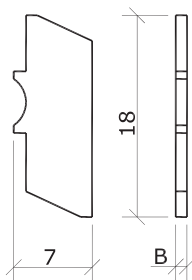

**Shim set for four-corner knives**

Art. Nr.	B
850061	4x0.1/0.2/0.5/1.0
850062	2x0.1/0.5/1.0/5.0 + 4x0.2/2.0

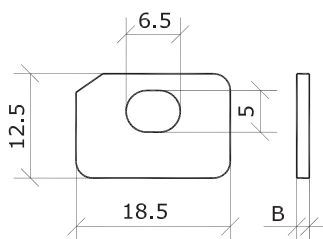

**Shims for four-corner knives PROTECT**

Art. Nr.	B
851275	0.1
851276	0.2
851278	0.5
851279	1.0

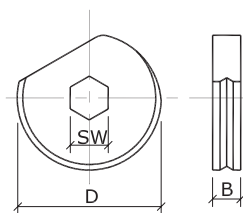

**Eccentric cam**

Art. Nr.	D	B	SW
851179	14	2.6	4
851184	19	3.7	5



**Setting gauge for reversible knives OERTLI**

Art. Nr.	B	h	a
851290	60	18	1.5

**KNIVES, SPARE PARTS, ACCESSORIES**

REVERSIBLE KNIVES>GROOVING KNIVES>PLANING KNIVES>KNIFE BLANKS>SPACERS, SLEEVES, BALL BEARINGS, GUIDE COLLARS>SCREWS, TORQUE WRENCHES, KEYS>HANDLING, MEASUREMENT, CLEANING

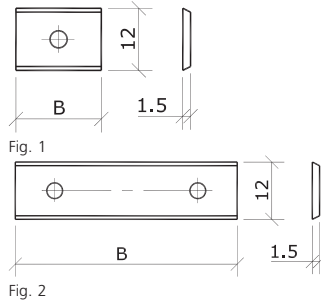

## Reversible knives, straight

**Design:** Packing unit 10 pieces

**Tungsten carbide quality H8, wedge angle 55°**

Art. Nr.	B	h	a	Qual.	Fig.
217705	7.5	12	1.5	HW	1
217708	9.6	12	1.5	HW	1
217709	11.6	12	1.5	HW	1
217706	12	12	1.5	HW	1
217710	15	12	1.5	HW	1
217715	20	12	1.5	HW	1
217718	25	12	1.5	HW	1
217720	30	12	1.5	HW	2
217724	40	12	1.5	HW	2
217725	50	12	1.5	HW	2
217728	60	12	1.5	HW	2
217730	80	13	2.2	HW	2
217731	100	13	2.2	HW	2
217732	120	13	2.2	HW	2

**Tungsten carbide quality H6, wedge angle 55°**

Art. Nr.	B	h	a	Qual.	Fig.
219700	7.5	12	1.5	HW	1
219701	9.6	12	1.5	HW	1
219702	10.5	12	1.5	HW	1
219703	11	12	1.5	HW	1
219704	13	12	1.5	HW	1
219705	15	12	1.5	HW	1
219706	15.7	12	1.5	HW	1
219707	17	12	1.5	HW	1
219708	18	12	1.5	HW	1
219709	19	12	1.5	HW	1
219710	20	12	1.5	HW	1
219711	24.7	12	1.5	HW	1
219712	24.7	12	1.5	HW	1
219713	30	12	1.5	HW	2
219714	40	12	1.5	HW	2
219715	50	12	1.5	HW	2
219716	60	12	1.5	HW	2











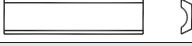



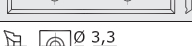

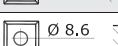
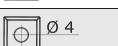
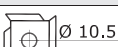

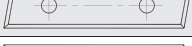

## Reversible knives, Format

**Design:** Packing unit 10 pieces

Art. Nr.	B	h	a	Typ	Qual.	
217736	29.5	12	1.5		HW	
217737	29.5	12	1.5		HW	
217707	50	12	1.7		HW	
217769	29.5	12	1.5		HW	
217768	14	14	2.0		HW	
217763	19	19	2.0		HW	

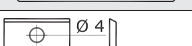
**KNIVES, SPARE PARTS, ACCESSORIES**

**REVERSIBLE KNIVES>GROOVING KNIVES>PLANING KNIVES>KNIFE BLANKS>SPACERS, SLEEVES, BALL BEARINGS, GUIDE COLLARS>SCREWS, TORQUE WRENCHES, KEYS>HANDLING, MEASUREMENT, CLEANING**

Art. Nr.	B	h	a	Typ	Qual.	
217739	20	5.5	1.1		HW	
217738	30	5.5	1.1		HW	
217802	23	10	1.5	re.	HW	
217808	23	10	1.5	li.	HW	
217803	19.3	7.7	1.5	re.	HW	
217807	19.3	7.7	1.5	li.	HW	
217752	49.5	9	1.5		HW	
217840	11	11	4.0		HW	
217760	12	12	1.5		HW	
217764	14	14	1.2		HW	
217766	17	17	2.0		HW	
217767	18	18	2.0		HW	
217781	48.6	12	1.5		HW	
217782	48.6	12	1.5		HW	
217783	49.2	12	1.5		HW	
217784	49.2	12	1.5		HW	
217838					HW	
217842					HW	
217839					HW	
217815					HW	
217819					HW	
217820	10.5	12	1.5		HW	
217824	13	12	1.5		HW	
217826	15.7	12	1.5		HW	

**KNIVES, SPARE PARTS, ACCESSORIES**

REVERSIBLE KNIVES>GROOVING KNIVES>PLANING KNIVES>KNIFE BLANKS>SPACERS, SLEEVES, BALL BEARINGS, GUIDE COLLARS>SCREWS, TORQUE WRENCHES, KEYS>HANDLING, MEASUREMENT, CLEANING



### Reversible knives, Format

**Design:** Packing unit 10 pieces

Art. Nr.	B	h	a	Qual.
217700	20	4.1	1.1	HW
217701	20	5.5	1.1	HW
217704	25	5.5	1.1	HW
217702	30	5.5	1.1	HW
217703	50	5.5	1.1	HW



### Reversible knives, Format

**Design:** Packing unit 10 pieces

Art. Nr.	B	h	a	Qual.
217770	30	12	1.5	HW
217775	45	15	1.5	HW

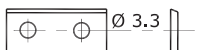

### Reversible knives, Format

**Design:** Packing unit 10 pieces

Art. Nr.	B	h	a	Qual.
217712	16	7	1.5	HW
217713	28	7	1.5	HW



### Reversible knives, Format

**Design:** Packing unit 10 pieces

Art. Nr.	B	h	a	Qual.
217810	56	5.5	1.1	HW
217805	80.5	5.9	1.2	HW
217800	82	5.5	1.1	HW



### Reversible knives, Format

**Design:** Packing unit 10 pieces

Art. Nr.	B	h	a	Qual.
217780	13	13	2.5	HW
217762	14.3	14.3	2.5	HW
217765	14	14	2.0	HW



### Reversible knives, Format

**Design:** Packing unit 10 pieces

Art. Nr.	B	h	a	Qual.
217833	10.8	5.5	1.1	HW
217834	11.3	5.5	1.1	HW
217835	13.3	5.5	1.1	HW
217843	15.3	5.5	1.1	HW
217836	15.8	5.5	1.1	HW
217837	18.3	5.5	1.1	HW

**KNIVES, SPARE PARTS, ACCESSORIES**

REVERSIBLE KNIVES>**GROOVING KNIVES**>PLANING KNIVES>KNIFE BLANKS>SPACERS, SLEEVES, BALL BEARINGS, GUIDE COLLARS>SCREWS, TORQUE WRENCHES, KEYS>HANDLING, MEASUREMENT, CLEANING

**Grooving knives OERTLI**

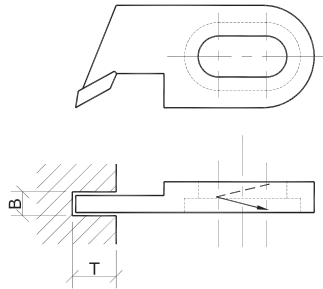

Fig. 1

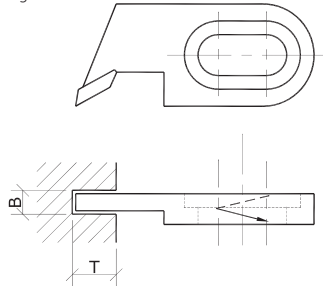

Fig. 2

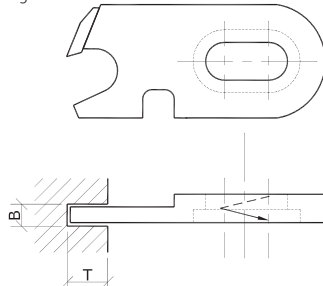

Fig. 3

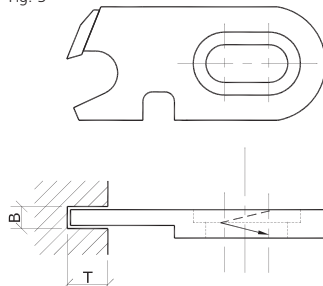

Fig. 4

**MEC (mechanical feed)**

Art. Nr.	B	T max.	Qual.	Fig.
855482	2.0	8	HW	1
855480	2.0	8	HW	1
855046	2.2	9	HW	2
855078	2.5	9	HW	2
855077	2.5	9	HW	1
855122	3.0	9	HW	2
855121	3.0	9	HW	1
855249	4.0	9	HW	1
855250	4.0	9	HW	2
855361	5.0	9	HW	1
855362	5.0	9	HW	2
855141	3.0	12	HW	1
855142	3.0	12	HW	2
855265	4.0	12	HW	1
855266	4.0	12	HW	2
855310	4.3	12	HW	2
855334	4.5	12	HW	2
855369	5.0	12	HW	1
855370	5.0	12	HW	2
855413	6.0	12	HW	1
855442	8.0	12	HW	2
855452	10.0	12	HW	2

**MAN (manual feed)**

Art. Nr.	B	T max.	Qual.	Fig.
855457	3.0	12	HW	3
855458	3.0	12	HW	4
855263	4.0	12	HW	3
855264	4.0	12	HW	4
855367	5.0	12	HW	3
855368	5.0	12	HW	4

**KNIVES, SPARE PARTS, ACCESSORIES**

REVERSIBLE KNIVES>**GROOVING KNIVES**>PLANING KNIVES>KNIFE BLANKS>SPACERS, SLEEVES, BALL BEARINGS, GUIDE COLLARS>SCREWS, TORQUE WRENCHES,  
KEYS>HANDLING, MEASUREMENT, CLEANING

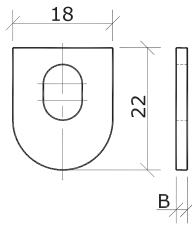

**Shims for grooving knives**

Art. Nr.	B
851283	0.1
851284	0.2
851285	0.5
851287	1.0
851286	2.0
851281	3.5

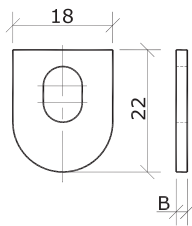

**Shim set for grooving knives**

Art. Nr.	B
850063	2x0.1/0.5/1.0/2.0 + 4x0.2



**KNIVES, SPARE PARTS, ACCESSORIES**

REVERSIBLE KNIVES>GROOVING KNIVES>**PLANING KNIVES**>KNIFE BLANKS>SPACERS, SLEEVES, BALL BEARINGS, GUIDE COLLARS>SCREWS, TORQUE WRENCHES, KEYS>HANDLING, MEASUREMENT, CLEANING

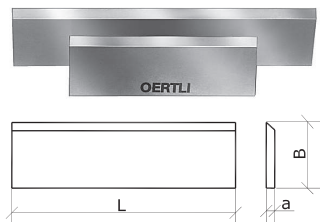

## Planing knives

### High-speed steel (HS)

Art. Nr.	L	B	a
450012	80	30	3.0
450014	100	30	3.0
450016	120	30	3.0
450018	130	30	3.0
450020	150	30	3.0
450022	160	30	3.0
450024	180	30	3.0
450026	200	30	3.0
450028	210	30	3.0
450030	230	30	3.0
450031	240	30	3.0
450032	250	30	3.0
450034	260	30	3.0
450036	300	30	3.0
450038	310	30	3.0
450040	350	30	3.0
450042	400	30	3.0
450044	410	30	3.0
450045	430	30	3.0
450046	450	30	3.0
450048	460	30	3.0
450050	500	30	3.0
450052	510	30	3.0
450054	550	30	3.0
450056	600	30	3.0
450058	610	30	3.0
450060	640	30	3.0
450061	660	30	3.0
450064	710	30	3.0
450066	810	30	3.0

### HS Super-Rapid

Art. Nr.	L	B	a
450082	80	30	3.0
450084	100	30	3.0
450086	120	30	3.0
450088	130	30	3.0
450092	160	30	3.0
450094	180	30	3.0
450096	200	30	3.0
450098	210	30	3.0
450100	230	30	3.0
450102	250	30	3.0
450104	260	30	3.0
450106	300	30	3.0
450108	310	30	3.0
450110	350	30	3.0
450112	400	30	3.0
450114	410	30	3.0
450116	450	30	3.0
450118	460	30	3.0
450120	500	30	3.0
450122	510	30	3.0
450124	550	30	3.0
450126	600	30	3.0
450128	610	30	3.0
450130	640	30	3.0

**KNIVES, SPARE PARTS, ACCESSORIES**REVERSIBLE KNIVES>GROOVING KNIVES>**PLANING KNIVES**>KNIFE BLANKS>SPACERS, SLEEVES, BALL BEARINGS, GUIDE COLLARS>SCREWS, TORQUE WRENCHES, KEYS>HANDLING, MEASUREMENT, CLEANING

Art. Nr.	L	B	a
450131	660	30	3.0
450132	680	30	3.0
450134	710	30	3.0
450136	810	30	3.0

**HS coated**

Art. Nr.	L	B	a
450458	100	35	3.0
450450	100	30	3.0
450451	130	30	3.0
450452	150	30	3.0
450459	150	35	3.0
450453	180	30	3.0
450454	230	30	3.0
450460	230	35	3.0
450455	260	30	3.0
450461	260	35	3.0
450456	310	30	3.0
450457	365	30	3.0
450462	365	35	3.0

**Tungsten carbide tipped**

Art. Nr.	L	B	a
450152	80	30	3.0
450154	100	30	3.0
450156	120	30	3.0
450158	130	30	3.0
450160	150	30	3.0
450162	160	30	3.0
450164	180	30	3.0
450166	200	30	3.0
450168	210	30	3.0
450170	230	30	3.0
450172	250	30	3.0
450174	260	30	3.0
450176	300	30	3.0
450178	310	30	3.0
450180	350	30	3.0
450182	400	30	3.0
450184	410	30	3.0
450186	450	30	3.0
450188	460	30	3.0
450190	500	30	3.0
450192	510	30	3.0
450194	550	30	3.0
450196	600	30	3.0
450198	610	30	3.0
450200	640	30	3.0
450202	680	30	3.0
450204	710	30	3.0
450206	810	30	3.0

**Solid tungsten carbide**

Art. Nr.	L	B	a
450512	80	30	3.0
450514	100	30	3.0
450516	120	30	3.0
450518	130	30	3.0
450519	140	30	3.0
450520	150	30	3.0

## KNIVES, SPARE PARTS, ACCESSORIES

REVERSIBLE KNIVES>GROOVING KNIVES>**PLANING KNIVES**>KNIFE BLANKS>SPACERS, SLEEVES, BALL BEARINGS, GUIDE COLLARS>SCREWS, TORQUE WRENCHES, KEYS>HANDLING, MEASUREMENT, CLEANING

Art. Nr.	L	B	a
450524	180	30	3.0
450525	185	30	3.0
450526	200	30	3.0
450528	210	30	3.0
450529	225	30	3.0
450530	230	30	3.0
450532	240	30	3.0
450534	260	30	3.0
450536	270	30	3.0
450537	300	30	3.0
450538	310	30	3.0
450539	330	30	3.0

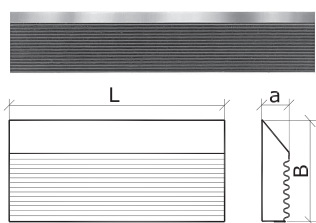

## Planing knives with back serration

### High-speed steel (HS)

Art. Nr.	L	B	a
450800	80	30	4
450801	130	30	4
450802	180	30	4
450803	210	30	4
450804	240	30	4

### Tungsten carbide (HW)

Art. Nr.	L	B	a
450810	80	30	4
450811	130	30	4
450812	180	30	4
450813	210	30	4
450814	240	30	4

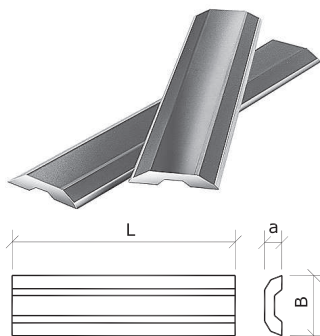

## Reversible knives for planing cutterheads SINUS

**Design:** HS-TRI • Tungsten carbide polished • 2 cutting edges, regrindable

### HS-TRI

Art. Nr.	L	B	a
469707	60	16.0	2.5
469708	80	16.0	2.5
469710	100	16.0	2.5
469712	120	16.0	2.5
469713	130	16.0	2.5
469736	136	16.0	2.5
469714	140	16.0	2.5
469715	150	16.0	2.5
469716	160	16.0	2.5
469718	180	16.0	2.5
469786	186	16.0	2.5
469719	190	16.0	2.5
469720	200	16.0	2.5
469721	210	16.0	2.5
469722	220	16.0	2.5
469723	230	16.0	2.5
469724	240	16.0	2.5
469725	250	16.0	2.5
469726	260	16.0	2.5
469730	300	16.0	2.5

**KNIVES, SPARE PARTS, ACCESSORIES**REVERSIBLE KNIVES>GROOVING KNIVES>**PLANING KNIVES**>KNIFE BLANKS>SPACERS, SLEEVES, BALL BEARINGS, GUIDE COLLARS>SCREWS, TORQUE WRENCHES, KEYS>HANDLING, MEASUREMENT, CLEANING

Art. Nr.	L	B	a
469731	310	16.0	2.5
469740	400	16.0	2.5
469741	410	16.0	2.5
469743	430	16.0	2.5
469750	500	16.0	2.5
469751	510	16.0	2.5
469761	610	16.0	2.5
469763	630	16.0	2.5
469764	640	16.0	2.5
469771	710	16.0	2.5
469798	1'350	16.0	2.5

**Tungsten carbide polished**

Art. Nr.	L	B	a
469950	80	16.3	2.5
469951	100	16.3	2.5
469952	120	16.3	2.5
469953	130	16.3	2.5
469954	140	16.3	2.5
469955	150	16.3	2.5
469956	160	16.3	2.5
469957	180	16.3	2.5
469958	200	16.3	2.5
469959	210	16.3	2.5
469960	220	16.3	2.5
469961	230	16.3	2.5
469962	240	16.3	2.5
469963	250	16.3	2.5
469964	260	16.3	2.5
469965	300	16.3	2.5

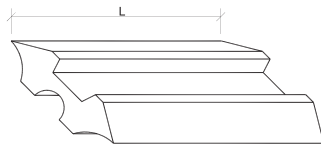
**Planing knives Tersa****High-speed steel (HS)**

Art. Nr.	L	B	a
449062	60	10	2.3
449072	70	10	2.3
449082	80	10	2.3
449092	90	10	2.3
449102	100	10	2.3
449112	110	10	2.3
449122	120	10	2.3
449132	130	10	2.3
449137	135	10	2.3
449142	140	10	2.3
449152	150	10	2.3
449162	160	10	2.3
449182	180	10	2.3
449187	185	10	2.3
449192	190	10	2.3
449202	200	10	2.3
449212	210	10	2.3
449222	220	10	2.3
449232	230	10	2.3
449237	235	10	2.3
449242	240	10	2.3

**KNIVES, SPARE PARTS, ACCESSORIES**REVERSIBLE KNIVES>GROOVING KNIVES>**PLANING KNIVES**>KNIFE BLANKS>SPACERS, SLEEVES, BALL BEARINGS, GUIDE COLLARS>SCREWS, TORQUE WRENCHES, KEYS>HANDLING, MEASUREMENT, CLEANING

Art. Nr.	L	B	a
449252	250	10	2.3
449262	260	10	2.3
449272	270	10	2.3
449282	280	10	2.3
449292	290	10	2.3
449302	300	10	2.3
449312	310	10	2.3
449322	320	10	2.3
449332	330	10	2.3
449342	340	10	2.3
449352	350	10	2.3
449362	360	10	2.3
449372	370	10	2.3
449382	380	10	2.3
449392	390	10	2.3
449402	400	10	2.3
449412	410	10	2.3
449502	500	10	2.3
449512	510	10	2.3
449520	520	10	2.3
449552	550	10	2.3
449572	570	10	2.3
449582	580	10	2.3
449612	610	10	2.3
449632	630	10	2.3
449642	640	10	2.3
449662	660	10	2.3

**HS-M42**

Art. Nr.	L	B	a
449063	60	10	2.3
449073	70	10	2.3
449083	80	10	2.3
449093	90	10	2.3
449103	100	10	2.3
449113	110	10	2.3
449123	120	10	2.3
449133	130	10	2.3
449143	140	10	2.3
449153	150	10	2.3
449163	160	10	2.3
449173	170	10	2.3
449183	180	10	2.3
449193	190	10	2.3
449203	200	10	2.3
449213	210	10	2.3
449223	220	10	2.3
449233	230	10	2.3
449243	240	10	2.3
449253	250	10	2.3
449263	260	10	2.3
449273	270	10	2.3
449283	280	10	2.3
449293	290	10	2.3
449303	300	10	2.3
449313	310	10	2.3
449323	320	10	2.3
449333	330	10	2.3
449343	340	10	2.3
449353	350	10	2.3

**KNIVES, SPARE PARTS, ACCESSORIES**REVERSIBLE KNIVES>GROOVING KNIVES>**PLANING KNIVES**>KNIFE BLANKS>SPACERS, SLEEVES, BALL BEARINGS, GUIDE COLLARS>SCREWS, TORQUE WRENCHES, KEYS>HANDLING, MEASUREMENT, CLEANING

Art. Nr.	L	B	a
449363	360	10	2.3
449373	370	10	2.3
449383	380	10	2.3
449393	390	10	2.3
449403	400	10	2.3
449413	410	10	2.3
449503	500	10	2.3
449513	510	10	2.3
449553	550	10	2.3
449573	570	10	2.3
449613	610	10	2.3
449633	630	10	2.3
449643	640	10	2.3
449663	660	10	2.3

**Tungsten carbide (HW)**

Art. Nr.	L	B	a
449061	60	10	2.3
449071	70	10	2.3
449081	80	10	2.3
449091	90	10	2.3
449101	100	10	2.3
449111	110	10	2.3
449121	120	10	2.3
449131	130	10	2.3
449136	135	10	2.3
449141	140	10	2.3
449151	150	10	2.3
449161	160	10	2.3
449171	170	10	2.3
449181	180	10	2.3
449186	185	10	2.3
449191	190	10	2.3
449201	200	10	2.3
449211	210	10	2.3
449221	220	10	2.3
449231	230	10	2.3
449236	235	10	2.3
449241	240	10	2.3
449251	250	10	2.3
449261	260	10	2.3
449271	270	10	2.3
449281	280	10	2.3
449291	290	10	2.3
449301	300	10	2.3
449311	310	10	2.3
449321	320	10	2.3
449331	330	10	2.3
449341	340	10	2.3
449351	350	10	2.3
449361	360	10	2.3
449371	370	10	2.3
449381	380	10	2.3
449391	390	10	2.3
449401	400	10	2.3

**KNIVES, SPARE PARTS, ACCESSORIES**

REVERSIBLE KNIVES>GROOVING KNIVES>**PLANING KNIVES**>KNIFE BLANKS>SPACERS, SLEEVES, BALL BEARINGS, GUIDE COLLARS>SCREWS, TORQUE WRENCHES, KEYS>HANDLING, MEASUREMENT, CLEANING

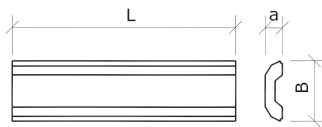

## Reversible knives for planing cutterheads

### HS coated

Art. Nr.	L	B	a
466629	115	12.0	2.6
466630	130	12.0	2.6
466631	180	12.0	2.6
466632	230	12.0	2.6

### Tungsten carbide polished

Art. Nr.	L	B	a
466640	130	12.7	2.6
466641	180	12.7	2.6
466642	230	12.7	2.6

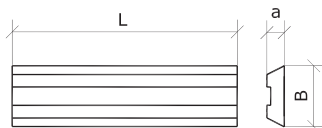

## Planing knives Centerlock

Art. Nr.	L	B	a	Qual.
450540	80	16	3.0	HS
450541	100	16	3.0	HS
450542	130	16	3.0	HS
450543	150	16	3.0	HS
450544	170	16	3.0	HS
450545	180	16	3.0	HS
450546	190	16	3.0	HS
450547	210	16	3.0	HS
450548	230	16	3.0	HS
450549	240	16	3.0	HS
450550	260	16	3.0	HS
450551	270	16	3.0	HS
450552	310	16	3.0	HS
450553	460	16	3.0	HS

**KNIVES, SPARE PARTS, ACCESSORIES**

REVERSIBLE KNIVES>GROOVING KNIVES>PLANING KNIVES>**KNIFE BLANKS**>SPACERS, SLEEVES, BALL BEARINGS, GUIDE COLLARS>SCREWS, TORQUE WRENCHES, KEYS>HANDLING, MEASUREMENT, CLEANING

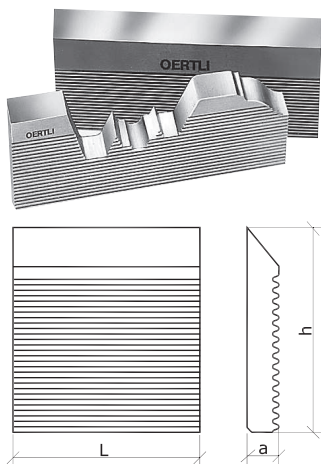

## Knife blanks with serrated back

### High-speed steel (HS)

Art. Nr.	L	h	a	T max.
468404	40	40	8.0	9
468406	60	40	8.0	9
468408	80	40	8.0	9
468410	100	40	8.0	9
468409	130	40	8.0	9
468411	170	40	8.0	9
468412	210	40	8.0	9
468413	240	40	8.0	9
468504	40	50	8.0	19
468506	60	50	8.0	19
468508	80	50	8.0	19
468510	100	50	8.0	19
468503	130	50	8.0	19
468511	170	50	8.0	19
468509	210	50	8.0	19
468507	240	50	8.0	19
468604	40	60	8.0	29
468606	60	60	8.0	29
468608	80	60	8.0	29
468610	100	60	8.0	29
468607	170	60	8.0	29
468609	210	60	8.0	29
468611	130	60	8.0	29
468613	240	60	8.0	29
468700	40	70	8.0	38
468705	60	70	8.0	38
468706	80	70	8.0	38
468710	100	70	8.0	38
468708	130	70	8.0	38
468709	170	70	8.0	38
468712	210	70	8.0	38
468711	240	70	8.0	38

### HS coated

Art. Nr.	L	h	a	T max.
468310	40	50	8.0	19
468311	50	50	8.0	19
468312	60	50	8.0	19
468313	80	50	8.0	19
468314	100	50	8.0	19
468315	120	50	8.0	19
468316	150	50	8.0	19
468317	180	50	8.0	19
468318	200	50	8.0	19
468319	230	50	8.0	19
468320	40	60	8.0	29
468321	50	60	8.0	29
468322	60	60	8.0	29
468323	80	60	8.0	29
468324	100	60	8.0	29
468325	120	60	8.0	29
468326	150	60	8.0	29
468327	180	60	8.0	29



**KNIVES, SPARE PARTS, ACCESSORIES**REVERSIBLE KNIVES>GROOVING KNIVES>PLANING KNIVES>**KNIFE BLANKS**>SPACERS, SLEEVES, BALL BEARINGS, GUIDE COLLARS>SCREWS, TORQUE WRENCHES, KEYS>HANDLING, MEASUREMENT, CLEANING

Art. Nr.	L	h	a	T max.
468328	200	60	8.0	29
468329	230	60	8.0	29
468330	40	70	8.0	38
468331	50	70	8.0	38
468332	60	70	8.0	38
468333	80	70	8.0	38
468334	100	70	8.0	38
468335	120	70	8.0	38
468336	150	70	8.0	38
468337	180	70	8.0	38
468338	200	70	8.0	38
468339	230	70	8.0	38

**KNIVES, SPARE PARTS, ACCESSORIES**

REVERSIBLE KNIVES>GROOVING KNIVES>PLANING KNIVES>KNIFE BLANKS>SPACERS, SLEEVES, BALL BEARINGS, GUIDE COLLARS>SCREWS, TORQUE WRENCHES, KEYS>HANDLING, MEASUREMENT, CLEANING

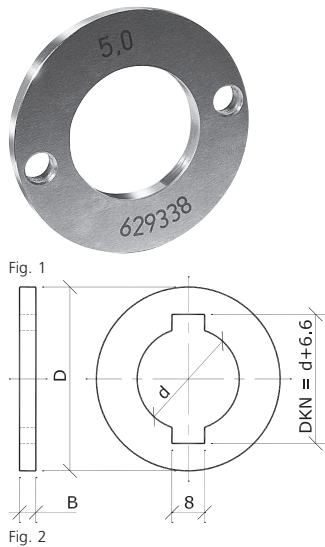

**Spacers**

Art. Nr.	d	B	D	NL	Fig.
629230	30	0.05	50		1
629232	30	0.10	50		1
629234	30	0.20	50		1
629236	30	0.50	50		1
629238	30	1.00	50		1
629240	30	2.00	50		1
629248	30	5.00	50		1
629258	30	10.00	50		1
629278	30	20.00	50		1
629322	30	0.05	55	2/7.0/45	1
629324	30	0.10	55	2/7.0/45	1
629326	30	0.20	55	2/7.0/45	1
629328	30	0.50	55	2/7.0/45	1
629330	30	1.00	55	2/7.0/45	1
629332	30	2.00	55	2/7.0/45	1
629338	30	5.00	55	2/6.5/45	1
629337	30	10.00	55	2/6.5/45	1
629339	30	20.00	55	2/6.5/45	1
629594	35	0.05	60	2/7.0/50	1
629596	35	0.10	60	2/7.0/50	1
629598	35	0.20	60	2/7.0/50	1
629600	35	0.50	60	2/7.0/50	1
629602	35	1.00	60	2/7.0/50	1
629604	35	2.00	60	2/7.0/50	1
629612	35	5.00	60	2/6.5/50	1
629613	35	10.00	60	2/6.5/50	1
629640	35	20.00	60	2/6.5/50	1
629814	40	0.05	65	2/7.0/55	1
629816	40	0.10	65	2/7.0/55	1
629818	40	0.20	65	2/7.0/55	1
629820	40	0.50	65	2/7.0/55	1
629822	40	1.00	65	2/7.0/55	1
629824	40	2.00	65	2/7.0/55	1
629832	40	5.00	65	2/6.5/55	1
629831	40	10.00	65	2/6.5/55	1
629833	40	20.00	65	2/6.5/55	1
629863	40	30.00	65		1
629867	40	40.00	65		1
629869	40	50.00	65		1
629990	45	0.05	70	6/7.0/60	1
629992	45	0.10	70	6/7.0/60	1
629994	45	0.20	70	6/7.0/60	1
629996	45	0.50	70	6/7.0/60	1
629998	45	1.00	70	6/7.0/60	1
630000	45	2.00	70	6/7.0/60	1
630009	45	5.00	70	4/6.5/60	1
630011	45	6.00	70	4/6.5/60	1
630012	45	7.00	70	4/6.5/60	1
630015	45	8.00	70	4/6.5/60	1
630016	45	9.00	70	4/6.5/60	1
630019	45	10.00	70	4/6.5/60	1
630021	45	11.00	70	4/6.5/60	1
630025	45	12.00	70	4/6.5/60	1
630027	45	13.00	70	4/6.5/60	1
630031	45	14.00	70	4/6.5/60	1
630033	45	15.00	70	4/6.5/60	1

**KNIVES, SPARE PARTS, ACCESSORIES**

 REVERSIBLE KNIVES>GROOVING KNIVES>PLANING KNIVES>KNIFE BLANKS>SPACERS, SLEEVES, BALL BEARINGS, GUIDE COLLARS>SCREWS, TORQUE  
 WRENCHES, KEYS>HANDLING, MEASUREMENT, CLEANING

Art. Nr.	d	B	D	NL	Fig.
630024	45	16.00	70	4/6.5/60	1
630035	45	17.00	70	4/6.5/60	1
630026	45	18.00	70	4/6.5/60	1
630037	45	19.00	70	4/6.5/60	1
630029	45	20.00	70	4/6.5/60	1
630158	50	0.05	75	6/7.0/65	1
630160	50	0.10	75	6/7.0/65	1
630162	50	0.20	75	6/7.0/65	1
630164	50	0.50	75	6/7.0/65	1
630166	50	1.00	75	6/7.0/65	1
630177	50	5.00	75	6/6.5/65	1
630186	50	10.00	75	6/7.0/65	1
630196	50	20.00	75	6/6.5/65	1
630264	55	0.05	80	6/7.0/70	1
630266	55	0.10	80	6/7.0/70	1
630268	55	0.20	80	6/7.0/70	1
630270	55	0.50	80	6/7.0/70	1
630272	55	1.00	80	6/7.0/70	1
630283	55	5.00	80	4/6.5/60	1
630291	55	10.00	80	4/6.5/60	1
630303	55	20.00	80	4/6.5/60	1
630436	60	0.05	85	6/7.0/75	1
630438	60	0.10	85	6/7.0/75	1
630440	60	0.20	85	6/7.0/75	1
630442	60	0.50	85	6/7.0/75	1
630444	60	1.00	85	6/7.0/75	1
630455	60	5.00	85	4/6.5/75	1
630456	60	6.00	85	4/6.5/75	1
630469	60	7.00	85	4/6.5/75	1
630460	60	8.00	85	4/6.5/75	1
630462	60	9.00	85	4/6.5/75	1
630465	60	10.00	85	4/6.5/75	1
630479	60	11.00	85	4/6.5/75	1
630466	60	12.00	85	4/6.5/75	1
630483	60	13.00	85	4/6.5/75	1
630484	60	14.00	85	4/6.5/75	1
630485	60	15.00	85	4/6.5/75	1
630470	60	16.00	85	4/6.5/75	1
630489	60	17.00	85	4/6.5/75	1
630472	60	18.00	85	4/6.5/75	1
630491	60	19.00	85	4/6.5/75	1
630475	60	20.00	85	4/6.5/75	1
630494	60	0.05	93	3/10/74	1
630496	60	0.10	93	3/10/74	1
630498	60	0.20	93	3/10/74	1
630500	60	0.50	93	3/10/74	1
630502	60	1.00	93	3/10/74	1
630510	60	5.00	93	3/10/74	1
630520	60	10.00	93	3/10/74	1
630584	65	0.05	90	6/7.0/80	1
630586	65	0.10	90	6/7.0/80	1
630588	65	0.20	90	6/7.0/80	1
630590	65	0.50	90	6/7.0/80	1
630592	65	1.00	90	6/7.0/80	1
630289	65	3.00	90	4/6.5/80	1
630601	65	4.00	90	4/6.5/80	1
630603	65	5.00	90	4/6.5/80	1
630604	65	6.00	90	4/6.5/80	1
630606	65	7.00	90	4/6.5/80	1
630607	65	8.00	90	4/6.5/80	1
630609	65	9.00	90	4/6.5/80	1

**KNIVES, SPARE PARTS, ACCESSORIES**REVERSIBLE KNIVES>GROOVING KNIVES>PLANING KNIVES>KNIFE BLANKS>SPACERS, SLEEVES, BALL BEARINGS, GUIDE COLLARS>SCREWS, TORQUE  
WRENCHES, KEYS>HANDLING, MEASUREMENT, CLEANING

Art. Nr.	d	B	D	NL	Fig.
630613	65	10.00	90	4/6.5/80	1
630619	65	11.00	90	4/6.5/80	1
630614	65	12.00	90	4/6.5/80	1
630621	65	13.00	90	4/6.5/80	1
630627	65	14.00	90	4/6.5/80	1
630629	65	15.00	90	4/6.5/80	1
630631	65	16.00	90	4/6.5/80	1
630633	65	17.00	90	4/6.5/80	1
630635	65	18.00	90	4/6.5/80	1
630637	65	19.00	90	4/6.5/80	1
630623	65	20.00	90	4/6.5/80	1
630625	65	30.00	90	4/6.5/80	1
630656	65	0.05	105	6/9.0/85	1
630658	65	0.10	105	6/9.0/85	1
630660	65	0.20	105	6/9.0/85	1
630662	65	0.50	105	6/9.0/85	1
630664	65	1.00	105	6/9.0/85	1
630673	65	5.00	105	4/8.5/85	1
630683	65	10.00	105	4/8.5/85	1
630693	65	20.00	105	4/8.5/85	1
207470	25+DKN	0.05	45		2
207471	25+DKN	0.10	45		2
207472	25+DKN	0.20	45		2
207473	25+DKN	0.50	45		2
207474	25+DKN	1.00	45		2
207475	25+DKN	4.00	45		2
207476	25+DKN	5.00	45		2
207477	25+DKN	10.00	45		2
207485	25+DKN	20.00	45		2
207484	25+DKN	40.00	45		2
207483	25+DKN	60.00	45		2
207460	30+DKN	0.05	50		2
207461	30+DKN	0.10	50		2
207462	30+DKN	0.20	50		2
207463	30+DKN	0.50	50		2
207464	30+DKN	1.00	50		2
207465	30+DKN	4.00	50		2
207466	30+DKN	5.00	50		2
207467	30+DKN	10.00	50		2
207482	30+DKN	50.00	50		2
207486	30+DKN	20.00	50		2

## KNIVES, SPARE PARTS, ACCESSORIES

REVERSIBLE KNIVES>GROOVING KNIVES>PLANING KNIVES>KNIFE BLANKS>SPACERS, SLEEVES, BALL BEARINGS, GUIDE COLLARS>SCREWS, TORQUE WRENCHES, KEYS>HANDLING, MEASUREMENT, CLEANING



Fig. 1

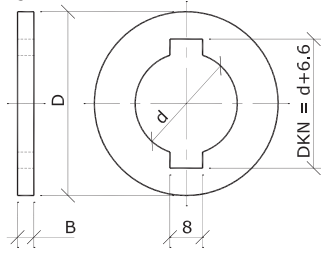
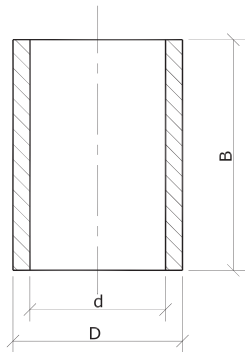

Fig. 2

## Shim- and spacer sets

Art. Nr.	d	B	D	NL	Fig.
631007	30	2x0.05/0.1/0.2/0.5/1.0/2.0	55	2/7.0/45	1
631008	40	2x0.05/0.1/0.2/0.5/1.0/2.0	65	2/7.0/55	1
629988	45	15x.01/15x0.2	70	6/7.0/60	1
630262	55	15x.01/15x0.2	80	6/7.0/65	1
630434	60	15x.01/15x0.2	85	6/7.0/75	1
630582	65	15x.01/15x0.2	90	6/7.0/80	1
630654	65	5x0.05/15x0.1/15x0.2	105	6/9.0/85	1
207480	25+DKN	2x0.05/0.1/0.2/2.0 + 1x0.5/1.0	45		2
207481	30+DKN	2x0.05/0.1/0.2/2.0 + 1x0.5/1.0	50		2

## Reducing sleeves without rim



Art. Nr.	d	D	B
640113	30	35	30
640120	30	40	10
640121	30	40	15
640123	30	40	30
640125	30	40	60
640130	30	50	10
640131	30	50	15
640133	30	50	30
640135	30	50	60

## Reducing sleeves with rim

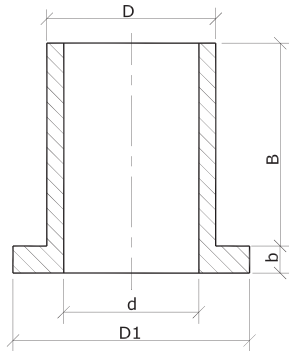

Art. Nr.	d	D	B	b	D1
640210	30	35	10	6	55
640212	30	35	20	6	55
640213	30	35	30	6	55
640220	30	40	10	6	60
640221	30	40	15	6	60
640222	30	40	20	6	60
640223	30	40	30	6	60
640230	35	40	20	6	60
640257	30	50	15	6	68
640256	30	50	20	6	68
640259	30	65	15	6	83
640258	40	50	15	6	68

## KNIVES, SPARE PARTS, ACCESSORIES

REVERSIBLE KNIVES>GROOVING KNIVES>PLANING KNIVES>KNIFE BLANKS>SPACERS, SLEEVES, BALL BEARINGS, GUIDE COLLARS>SCREWS, TORQUE WRENCHES, KEYS>HANDLING, MEASUREMENT, CLEANING

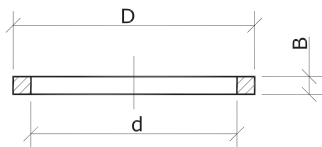

### Reducing rings for circular saw blades

Art. Nr.	d	D	B
640331	16	18	2.2
640334	15	20	2.0
640335	16	20	1.6
640338	20	22	1.6
640310	15	30	2.2
640311	16	30	2.2
640313	20	30	2.2
640315	25	30	2.2
640358	30	32	2.2
640320	30	35	2.2
640325	30	40	2.0
640378	30	50	2.8
640381	30	60	2.8



### Ball bearings

Art. Nr.	d	D
645030	30	62
645040	40	80

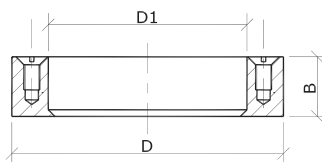
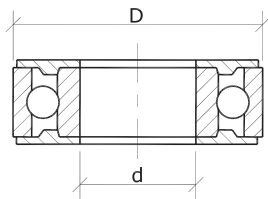

### Guide collars

Art. Nr.	D	D1	B
646080	80	62	18
646090	90	62	18
646100	100	62	18
646110	110	62	18
646115	115	62	18
646120	120	62	18
646125	125	62	18
646130	130	62	18
646140	140	62	18
646160	160	62	18
646205	140	80	20

## KNIVES, SPARE PARTS, ACCESSORIES

REVERSIBLE KNIVES>GROOVING KNIVES>PLANING KNIVES>KNIFE BLANKS>SPACERS, SLEEVES, BALL BEARINGS, GUIDE COLLARS>**SCREWS, TORQUE WRENCHES, KEYS**>HANDLING, MEASUREMENT, CLEANING

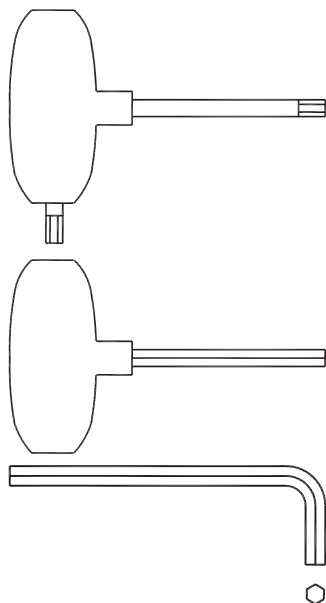

## Keys

### Torx keys with cross-handle

Art. Nr.	Typ
850071	Torx 9
850081	Torx 10
850084	Torx 15
850089	Torx 20
850094	Torx 25

### Allen keys with cross-handle

Art. Nr.	Typ
850055	ISK 3
850052	ISK 4
850264	ISK 5
850054	ISK 6

### Allen keys

Art. Nr.	Typ
850002	ISK 2
850004	ISK 2.5
850006	ISK 3
850008	ISK 4
850010	ISK 5
850012	ISK 6

## Key set, 7-parts

Art. Nr.	Typ
850019	ISK 4/ISK 5/Torx 20/Torx 10/Torx 15/Torx 20/Torx 25



## Torque wrench

### Set 13-parts

Art. Nr.
850265

### Set 17-parts

Art. Nr.
850266

### Torque wrench

Art. Nr.	Typ
850247	2 Nm
850248	4 Nm

### Torque wrench with cross-handle

Art. Nr.	Typ
850255	6.5 Nm
850263	8.0 Nm

**KNIVES, SPARE PARTS, ACCESSORIES**

REVERSIBLE KNIVES>GROOVING KNIVES>PLANING KNIVES>KNIFE BLANKS>SPACERS, SLEEVES, BALL BEARINGS, GUIDE COLLARS>**SCREWS, TORQUE WRENCHES, KEYS**>HANDLING, MEASUREMENT, CLEANING

## Interchangeable blades for torque wrench

### Torque wrench

Art. Nr.	Typ
850262	Torx 10
850244	Torx 15
850245	Torx 20
850246	Torx 25
850249	ISK 2.5
850250	ISK 3
850251	ISK 4

### Torque wrench with cross-handle

Art. Nr.	Typ
850256	Torx 10
850257	Torx 20
850258	Torx 25
850259	ISK 4
850260	ISK 5



**KNIVES, SPARE PARTS, ACCESSORIES**

REVERSIBLE KNIVES>GROOVING KNIVES>PLANING KNIVES>KNIFE BLANKS>SPACERS, SLEEVES, BALL BEARINGS, GUIDE COLLARS>**SCREWS, TORQUE WRENCHES, KEYS**>HANDLING, MEASUREMENT, CLEANING

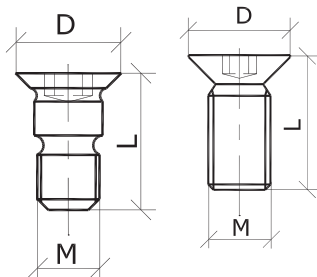

Fig. 1

Fig. 2

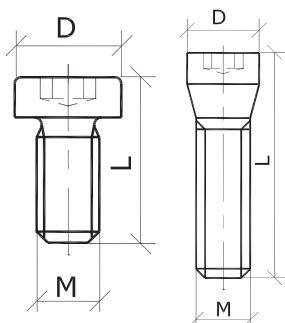

Fig. 3

Fig. 4

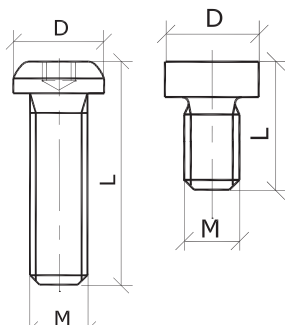

Fig. 5

Fig. 6

**Screws**

**Countersunk head screws with seating fit**

Art. Nr.	M	D	L	Typ	Fig.
851032	5	8.5	11	Torx 20	1
851017	5	10	11	Torx 20	1
851046	5	8.5	15	Torx 20	1
851040	5	8.5	15.5	Torx 20	1
851020	6	10.3	12	Torx 20	1

**Countersunk head screws**

Art. Nr.	M	D	L	Typ	Fig.
851038	5	8	6.3	Torx 20	2
851027	5	9.2	11.5	Torx 25	2
851039	5	8.4	12	Torx 20	2
851023	6	10.3	9	Torx 20	2
851060	6	9.8	13	Torx 20	2
851190	6	11.7	16	ISK 5	2
851498	8	16	20	ISK 6	2
851109	8	20	20.7	ISK 6	2

**Socket head cap screws**

Art. Nr.	M	D	L	Typ	Fig.
851084	4	12	8.5	ISK 3	3
851031	4	7	10	Torx 15	3
851030	5	8.5	10	Torx 25	3
851001	6	10	16	ISK 5	3

**Socket head cap screws, conical**

Art. Nr.	M	D	L	Typ	Fig.
851074	4	6.5	10	Torx 20	4
851075	4	6.5	12	Torx 20	4
851077	4	6.5	16	Torx 20	4
851076	4	6.5	19	Torx 20	4
851078	4	6.5	22	Torx 20	4
851059	5	6.8	23	Torx 20	4
851166	6	8	25	Torx 25	4
851153	6	9.5	26	Torx 25	4
851148	6	8	28	ISK 5	4
851145	6	9.5	28	ISK 5	4

**Special screws**

Art. Nr.	M	D	L	Typ	Fig.
851062	5	9.0	6.3	Torx 20	5
851098	6	10.0	8	ISK 5	5
851099	6	10.5	10	ISK 5	5
851100	6	10.5	12	ISK 5	5
851347	6	9.5	20	Torx 20	5

**Square head screws**

Art. Nr.	M	D	L	Typ	Fig.
851209	8	10	14.0	SW10	6
851625	10	14	14.5	SW14	6
851208	10	14	16.5	SW14	6

**KNIVES, SPARE PARTS, ACCESSORIES**

REVERSIBLE KNIVES>GROOVING KNIVES>PLANING KNIVES>KNIFE BLANKS>SPACERS, SLEEVES, BALL BEARINGS, GUIDE COLLARS>**SCREWS, TORQUE WRENCHES, KEYS**>HANDLING, MEASUREMENT, CLEANING

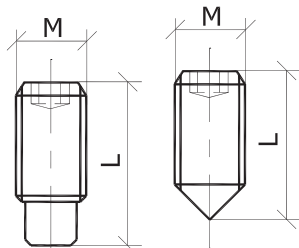

Fig. 1

Fig. 2

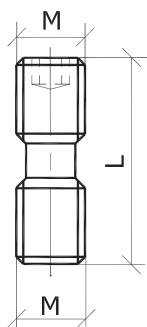

Fig. 3

**Set screws**

**Set screws**

Art. Nr.	M	L	Typ	Fig.
851447	5	6	ISK 2	1
851549	6	12	ISK 3	1
851590	6	16	ISK 3	1
851487	6	8	ISK 3	1
851420	8	20	ISK 4	1
851421	8	25	ISK 4	1

**Set screws with cone point**

Art. Nr.	M	L	Typ	Fig.
851419	6	20	ISK 3	2

**Set screws left/right**

Art. Nr.	M	L	Typ	Fig.
851340	5	15	Torx 10	3
851341	6	18	Torx 15	3

#### KNIVES, SPARE PARTS, ACCESSORIES

REVERSIBLE KNIVES>GROOVING KNIVES>PLANING KNIVES>KNIFE BLANKS>SPACERS, SLEEVES, BALL BEARINGS, GUIDE COLLARS>SCREWS, TORQUE WRENCHES, KEYS>HANDLING, MEASUREMENT, CLEANING



### Tool installation device, simple

**Application:** As working aid by tool assembly as well as for inserted knife change

**Design:** With aluminium clamping jaws • With quick clamping lever

Art. Nr.	Typ
676838	HSK 63F (Weeke/Homag Aggregate)
676842	HSK 63F, HSK 63E
676840	SK 30, HSK 50
676841	SK 40
676843	SCM 30



### Tool installation device, pivotable

**Application:** As working aid by tool assembly as well as for inserted knife change

**Design:** Pivotable

Art. Nr.	Typ
676830	HSK 63F, HSK 63E



## KNIVES, SPARE PARTS, ACCESSORIES

REVERSIBLE KNIVES>GROOVING KNIVES>PLANING KNIVES>KNIFE BLANKS>SPACERS, SLEEVES, BALL BEARINGS, GUIDE COLLARS>SCREWS, TORQUE WRENCHES, KEYS>HANDLING, MEASUREMENT, CLEANING



### Tool installation device, pivotable

**Application:** As working aid by tool assembly as well as for inserted knife change

**Design:** With quick clamping lever •Pivotable

Art. Nr.	Typ
676831	HSK-P

#### Spare parts

##### Art.Nr.

206903	Clamping shafts HSK-P, d=30+DKN A=26 L1=164 Typ=HSK-P n max=12'000
629330	Spacers, d=30 B=1.00 D=55 NL=2/7.0/45
629332	Spacers, d=30 B=2.00 D=55 NL=2/7.0/45
629337	Spacers, d=30 B=10.00 D=55 NL=2/6.5/45
629338	Spacers, d=30 B=5.00 D=55 NL=2/6.5/45
629339	Spacers, d=30 B=20.00 D=55 NL=2/6.5/45
640220	Reducing sleeves with rim, d=30 D=40 B=10 b=6 D1=60
640257	Reducing sleeves with rim, d=30 D=50 B=15 b=6 D1=68
640259	Reducing sleeves with rim, d=30 D=65 B=15 b=6 D1=83



### Measuring plate

Art. Nr.	D	B	d	Typ
676839	195	50	40	HSK 63F



### Digital measuring scale for measuring plate

Art. Nr.	L
676051	365

#### KNIVES, SPARE PARTS, ACCESSORIES

REVERSIBLE KNIVES>GROOVING KNIVES>PLANING KNIVES>KNIFE BLANKS>SPACERS, SLEEVES, BALL BEARINGS, GUIDE COLLARS>SCREWS, TORQUE WRENCHES, KEYS>HANDLING, MEASUREMENT, CLEANING



### Digital longitudinal measuring device

Art. Nr.	L
676052	300

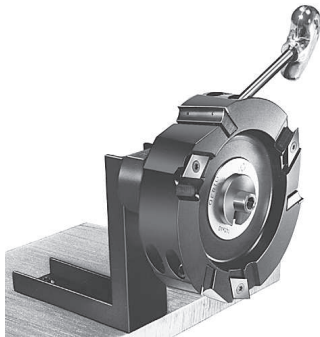

### Tool holder

**Design:** For tools with bore 30-50mm, maximum clamping length 90mm

Art. Nr.
633005



### Setting device Hebor

Art. Nr.
636099

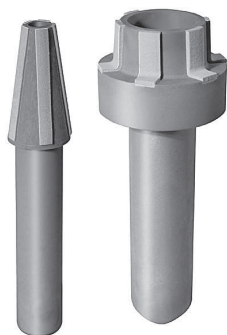

### Cone cleaner

**Application:** For soft and efficient cleaning of SK- and HSK machine spindles

**Design:** Plastic body, fully coated for best oil- and grease resistance

Art. Nr.	Typ
635113	SK 30
635114	SK 40
635115	HSK 63F

## KNIVES, SPARE PARTS, ACCESSORIES

REVERSIBLE KNIVES>GROOVING KNIVES>PLANING KNIVES>KNIFE BLANKS>SPACERS, SLEEVES, BALL BEARINGS, GUIDE COLLARS>SCREWS, TORQUE WRENCHES, KEYS>HANDLING, MEASUREMENT, CLEANING



### Resin removal and cleaning agent

#### For tool body in steel

Art. Nr.	Typ
635060	5 Liter
635062	25 Liter

#### For tool body in steel and aluminum

Art. Nr.	Typ
635080	5 Liter

### Grinding oil

Art. Nr.	Typ
635050	5 Liter



### Lubrication spray

Art. Nr.
635065

### Loctite for securing threads

Art. Nr.	Typ
2360880	LOCTITE Typ 222 / 50ml



### Washing machine

**Application:** For economical cleaning and removal of grease, oil, resin, wax, colours, chips, etc.

**Design:** Useful volume type Mini: Diameter 410mm, height 180mm / Useful volume type Standard: Diameter 610mm, height 400mm • Design in stainless steel • Fully-automated working operation • Built-in time clock • Optimized cleaning • Minimized cleaning costs • High duration of life • Fast drying

Art. Nr.	Typ
635120	Mini
635121	Standard

## KNIVES, SPARE PARTS, ACCESSORIES

REVERSIBLE KNIVES>GROOVING KNIVES>PLANING KNIVES>KNIFE BLANKS>SPACERS, SLEEVES, BALL BEARINGS, GUIDE COLLARS>SCREWS, TORQUE WRENCHES, KEYS>HANDLING, MEASUREMENT, CLEANING



### Work bench

**Design:** Stable and powder-coated sheet metal construction • Work table made-up of 40mm beech • Extensible back plate with holes • Pivotal and revolving vice • Sinkable castors on tool trolley • Length 1250mm, Width 700mm, Height 840mm

Art. Nr.

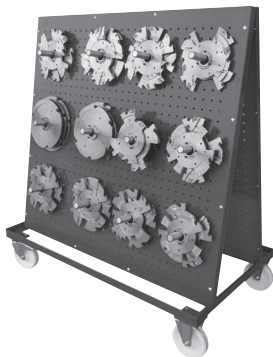

### Tool trolley for tools with bore

**Application:** For workmanlike transport and storage of tool sets with bore

**Design:** Stable metal construction • Weight per tool set up to abt. 20kg; total weight up to abt. 600kg • Adjustable mandrel for various tool diameters • Maximum tool diameter 420mm

Art. Nr.

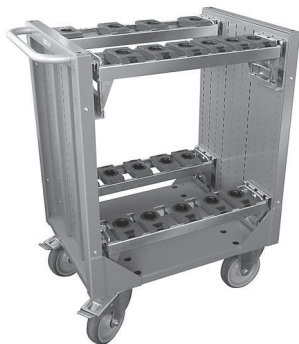

### Tool trolley

**Application:** For workmanlike transport and storage of tool sets with HSK adaptors

**Design:** Welded construction of quality sheet metal • Quick hang-up of tool holders without fastening screws

Art. Nr.