

fiok

MADE IN ITALY

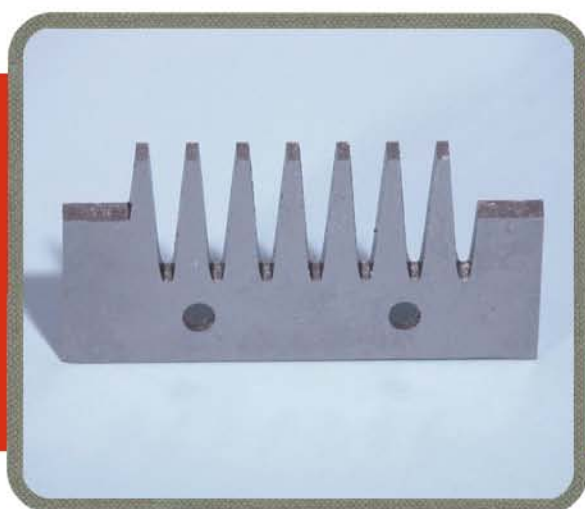

RICAMBI E ACCESSORI

SPARE PARTS

CATALOGO

**46 - R
2016**

CONDIZIONI GENERALI DI VENDITA

ORDINI

Le ordinazioni si intendono accettate alle condizioni indicate nella conferma d'ordine e non potranno essere annullate né parzialmente né totalmente dal Committente. In mancanza di conferma d'ordine valgono le nostre condizioni generali di vendita.

CONSEGNE

I termini di consegna pattuiti decorrono dalla data di definizione di tutti i dettagli inerenti l'ordinazione e saranno nel possibile rispettati. Eventuali ritardi, conseguenze di disagi indipendenti dalla nostra volontà, non potranno essere motivo di annullamento o di richieste di indennizzi di nessun genere.

SPEDIZIONI

La merce viene resa franco nostro stabilimento e spedita, salvo accordi diversi, con il mezzo più vantaggioso. La merce viaggerà sempre a rischio e pericolo del committente. Eventuali assicurazioni dovranno essere esplicitamente richieste e saranno fatturate al costo. L'imballo è sempre a carico del committente ed addebitato al costo.

GARANZIA

Tutti i nostri utensili sono sottoposti ad accurati controlli e sono completamente garantiti. Si declina qualsiasi responsabilità per danni diretti ed indiretti dovuti all'utilizzo improprio dei materiali, dal logorio, da danni causati dal trasporto, da modifiche effettuate senza la nostra approvazione od alla non osservanza delle norme e delle condizioni di impiego indicate su utensili, manuali o cataloghi e sito internet.

RESTITUZIONI E RECLAMI

Non si accettano restituzioni della merce, a nessun titolo, se non preventivamente autorizzate da FINK srl. I reclami per merce sbagliata o difettosa dovranno essere inviati alla nostra sede esclusivamente tramite documentazione scritta indicante il difetto riscontrato, entro 8 giorni dal ricevimento della merce.

PREZZI

I prezzi si intendono I.V.A. esclusa, che sarà applicata con l'aliquota vigente al momento della spedizione. La merce si intende fornita franco nostra fabbrica e l'imballo è a carico del committente. Salvo accordi particolari comprovati dalla conferma d'ordine, vengono applicati i prezzi di listino in vigore alla data dell'ordine della merce. Fori speciali a partire da € 8,00.

PAGAMENTI

Gli importi delle fatture vanno pagati per intero alle scadenze stabilite e direttamente a FINK srl. Non sono ammessi arrotondamenti o trattenute arbitrarie. Tutte le spese accessorie sono a carico del cliente. Il mancato rispetto dei termini di pagamento autorizza FINK srl, al recupero di ogni spesa accessoria, agli interessi maturati secondo quanto previsto dal D.Lgs 9/10/2002 n.231, ci riserviamo inoltre il diritto alla sospensione di eventuali ordini in corso. La merce rimane proprietà di FINK srl fino al pagamento totale della fornitura e delle eventuali spese accessorie.

DIRITTI D'AUTORE

Tutti i diritti sono riservati a norma di legge. FINK srl fa divieto a chiunque di copiare, riprodurre testi, disegni, illustrazioni in modo totale o parziale, senza il suo consenso scritto.

FORO COMPETENTE

Per qualsiasi controversia, il foro competente è esclusivamente quello di Monza. I contratti, anche se stipulati con acquirenti stranieri o per materiali forniti all'estero sono regolati dalla legislazione Italiana.

SPECIFICAZIONI E DISEGNI

I prodotti FINK srl sono soggetti a continue innovazioni; ci si riserva il diritto di apportare le modifiche ed i miglioramenti ritenuti opportuni senza incorrere in alcun tipo di obbligazione per quelli già venduti.

GENERAL TERMS OF SALE

ORDERS

Orders are accepted with the conditions indicated in the order confirmation and may neither be totally nor partially cancelled by the customer. Without an order confirmation are valid our general terms of sale.

DELIVERY TERMS

The delivery dates are only indicative and will be respected as much as possible and start from the date when all the details concerning the order are defined. Possible delays, due to unexpected events, that do not depend from our, will cannot be reason of claim, cancellation of the order or request for any compensation

SHIPMENTS

Goods are delivered ex-factory and with the most advantageous forwarding agent, except different agreements with the buyer. Freight costs and risks will be at the charge of the buyer. Shipment will be covered by insurance guarantee only if expressly requested by the buyer and charged at cost. No claim can be entertained in case of goods short delivered, damaged or lost in transit. Packing is at the charge of the buyer and debited at the real cost.

GUARANTEE

All our tools are carefully controlled and guaranteed. The guarantee does not include damages caused during the transport, defects due to wear, wrong or improper use, non maintenance, handlings or modifications made without our approval, the failure to comply with the safety rules and the instructions of use indicated on the tools, catalogues, guides or web-site.

RETURNS AND CLAIMS

Fink does not accept returns of the goods if not previously authorized. Claims for wrong or defective goods have to be communicated only in writing within 8 days from the receipt of the goods mentioning the description of the defect.

PRICES

Prices are considered ex-factory without V.A.T., which will be imposed with the share in force during the invoicing. The packing is at the charge of the buyer. Except particular agreements stated in the order confirmation we will apply the price-list in force at the moment of the order. Extra cost for special bores from € 8,00.

PAYMENTS

The invoices amounts have to be fully paid, on stated maturity, to Fink S.r.l. All extra charges are at the customer expense. Payments may not be rounded down or reduced under any circumstances. If the terms of payment are not honoured Fink S.r.l. can interrupt new supplies and debit all the due interests as well as any additional expense. The delivery terms will be automatically extended. The passing of property of the products supplied by Fink S.r.l. to the customer will take place after complete settlement of the invoices.

RESERVED OWNERSHIP RIGHTS

All rights are reserved in accordance with the law and international agreements. This catalogue not be reproduced or copied (even in part) without prior and written authorization on the part of Fink S.r.l.

PLACE OF JURISDICTION

For any legal matter the place of jurisdiction is Monza. The contracts, even if defined with foreign Buyers or for goods to be sent abroad, are regulated by the Italian legislation.

SPECIFICATION AND DRAWINGS

Our tools are subject to continuous innovations, we reserve the right to make improvements and modifications that we consider appropriate without incurring in any kind of duty for the products already sold.

THE PRICE-LIST 2011 CANCEL AND REPLACES THE PREVIOUS ONE.



RICAMBI E ACCESSORI - SPARE PARTS

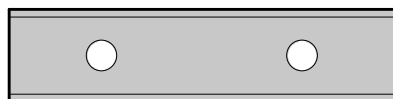

COLTELLINI HW STANDARD
STANDARD HW KNIVES

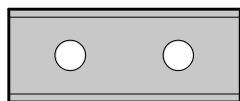
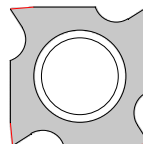
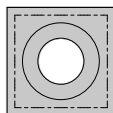

ART. 180 => 201



**COLTELLI PER PIALLA
TERSA - CENTROLOCK -
CENTROFIX**

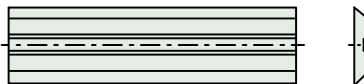

ART. 125 - 129

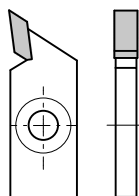

INSERTI SPECIALI
SPECIAL KNIVES

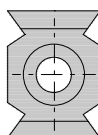

ART. 202 =>

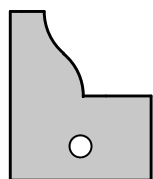

COLTELLI PROFILATI HSS e HW
PROFILED HSS and HW KNIVES

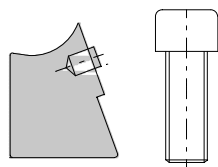

RICAMBI PER UTENSILI
SPARE PARTS

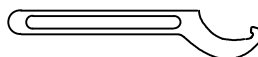

ACCESSORI
ACCESSORIES

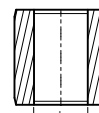
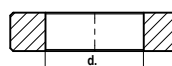
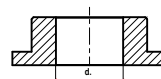
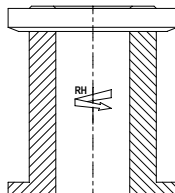

VASCHE DI LAVAGGIO AD ULTRASUONI
ULTRASONIC TOOL CLEANER

CATALOGO 46 R 2016

5/CU ANELLI CON CUSCINETTO

BALL BEARING SET

D.=90-95-100-105-110-115-120-125-130 FORO 30-31.75-35-40
BORE 30-31.75-35-40

D.100-105-110-115-120-125-130-135-140 FORO 50
BORE 50

5/CU

Codice nr.	D.	B	d.
	mm.	mm.	mm.

5/CU 30	90-130	16.5	30
5/CU 31	90-130	16.5	31.75
5/CU 35	90-130	16.5	35
5/CU 40	90-130	16.5	40
5/CU 50	100-140	18.5	50

IL SET E' COMPOSTO DA:

THE SET INCLUDES:

1 CUSCINETTO + 9 ANELLI IN ACCIAIO

1 BALL BEARING + 9 STEEL BUTTING RINGS



5/CU S

Codice nr.	D.	B	d.
	mm.	mm.	mm.

5/CU S30	90-130	16.5	30
5/CU S31	90-130	16.5	31.75
5/CU S35	90-130	16.5	35
5/CU S40	90-130	16.5	40
5/CU S50	100-140	18.5	50

IL SET E' COMPOSTO DA:

THE SET INCLUDES:

COME 5/CU + SCATOLA IN LEGNO

AS 5/CU + WOOD BOX



5/CU C CUSCINETTO/BALL BEARING

Codice nr.	D.	B	d.
	mm.	mm.	mm.

5/CU C30	62		30
5/CU C31	62		31.75
5/CU C35	62		35
5/CU C40	62		40
5/CU C50	80		50

BEDANI STANDARD E SPECIALI

STANDARD AND SPECIAL MORTISE CHISELS

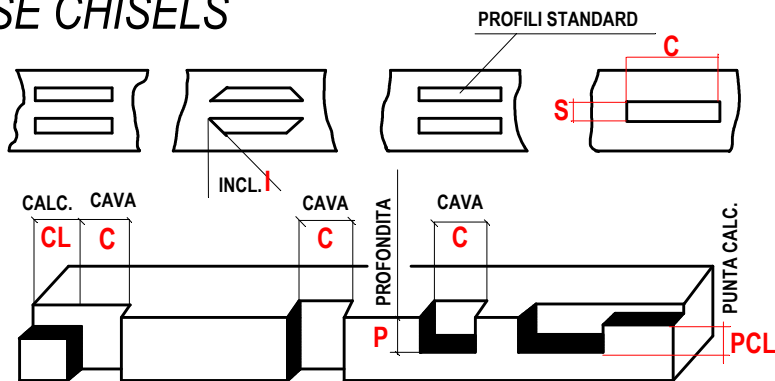
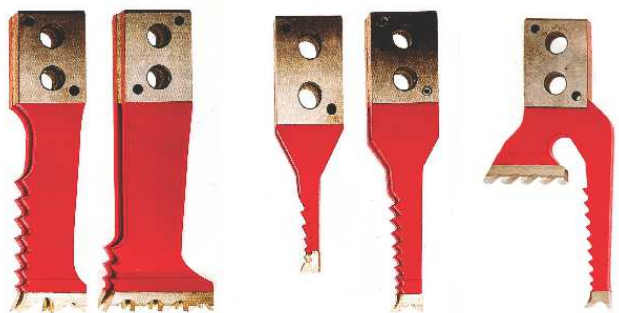

BEDANI SENZA CALCAGNO

MORTISE CHISELS WITHOUT HEEL

CAVA HOLE mm.	SPESSORE WIDTH mm.	PROF. DEPTH mm.max	DENTI TEETH	SINGOLO SINGLE	DOPPIO DOUBLE	SINGOLO INCL. INCL.SINGLE	DOPPIO INCL. DOUBLE INCL.
25/35	6/9	50/60		CODICE B25/35	CODICE B25/35D	CODICE B25/35I	CODICE B25/35DI
30/40	10/14	50/60		B30/40	B30/40D	B30/40I	B30/40DI
35/45	15/20	50/60		B35/45	B35/45D	B35/45I	B35/45DI
40/50	6/9	70/80		B40/50	B40/50D	B40/50I	B40/50DI
45/55	10/14	70/80		B45/55	B45/55D	B45/55I	B45/55DI
50/60	15/20	70/80		B50/60	B50/60D	B50/60I	B50/60DI
55/65	6/9	80/100		B55/65	B55/65D	B55/65I	B55/65DI
60/70	10/14	80/100		B60/70	B60/70D	B60/70I	B60/70DI
65/75	15/20	80/100		B65/75	B65/75D	B65/75I	B65/75DI
70/80	6/9	90/110		B70/80	B70/80D	B70/80I	B70/80DI
75/85	10/14	90/110		B75/85	B75/85D	B75/85I	B75/85DI
80/90	15/20	90/110		B80/90	B80/90D	B80/90I	B80/90DI
85/95	6/9	100/120		B85/95	B85/95 D	B85/95 I	B85/95 DI
90/100	10/14	100/120		B90/100	B90/100 D	B90/100I	B90/100DI
95/105	15/20	100/120		B95/105	B95/105 D	B95/105I	B95/105DI
100/110	6/9	100/120		B100/110	B100/110 D	B100/110I	B100/110DI
105/115	10/14	100/120		B105/115	B105/115 D	B105/115I	B105/115DI
110/120	15/20	100/120		B110/120	B110/120 D	B110/120I	B110/120DI
130	10/20	120	SERRATURE	BS130			
180	10/20	120	LOCKS	BS180			

INDICARE IL TIPO DI MACCHINA
TYPE MORTISE

BEDANI CON CALCAGNO

MORTISE CHISELS WITH HEEL

CAVA HOLE mm.	SPESSORE WIDTH mm.	CALCAGNO HEEL mm.	DENTI TEETH	SINGOLO SINGLE	DOPPIO DOUBLE	SINGOLO INCL. INCL.SINGLE	DOPPIO INCL. DOUBLE INCL.
30/40	6/12	50		CODICE BC30/40	CODICE BC30/40D	CODICE BC30/40 I	CODICE BC30/40 DI
40/50	6/12	70		BC40/50	BC40/50D	BC40/50 I	BC40/50 DI
50/60	6/12	65		BC50/60	BC50/60D	BC50/60 I	BC50/60 DI
60/70	6/12	80		BC60/70	BC60/70D	BC60/70 I	BC60/70 DI
70/80	6/12	65		BC70/80A	BC70/80A D	BC70/80A I	BC70/80A DI
70/80	6/12	80		BC70/80B	BC70/80B D	BC70/80B I	BC70/80B DI
80/90	6/12	65		BC80/90A	BC80/90A D	BC80/90A I	BC80/90A DI
80/90	6/12	80		BC80/90B	BC80/90B D	BC80/90B I	BC80/90B DI
90/100	6/12	65		BC90/100A	BC90/100AD	BC90/100AI	BC90/100ADI
90/100	6/12	80		BC90/100B	BC90/100BD	BC90/100BI	BC90/100BDI

TIPO BEDANATRICE
TYPE MORTISE

CATENE MORTASATRICI

MORTISING CHAINS



PASSO "A" mm CATENA CON 36 MAGLIE

PASSO "B" mm CATENA CON 48 MAGLIE

PASSO "C" mm CATENA CON 54 MAGLIE

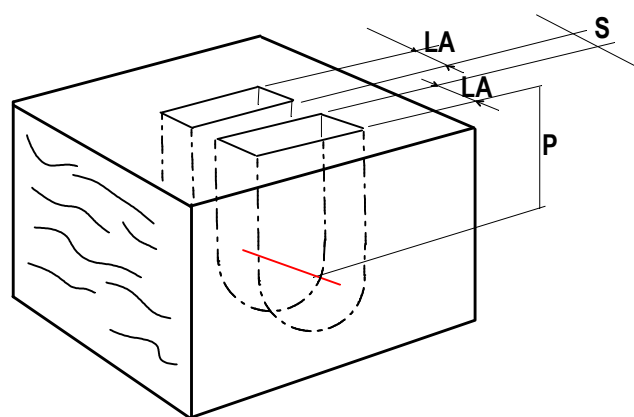

MISURE NECESSARIE:

LA =

LU =

P =

S =

E =

LA = LARGHEZZA CAVA

LU = LUNGHEZZA CAVA

P = PROFONDITA' CAVA

S = SPESSORE LEGNO TRA LE CAVE

E = INTERASSE "E" DELLA MACCHINA

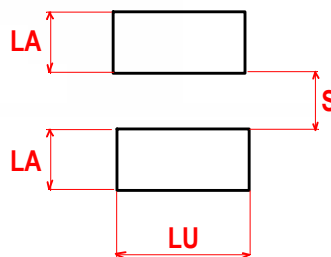
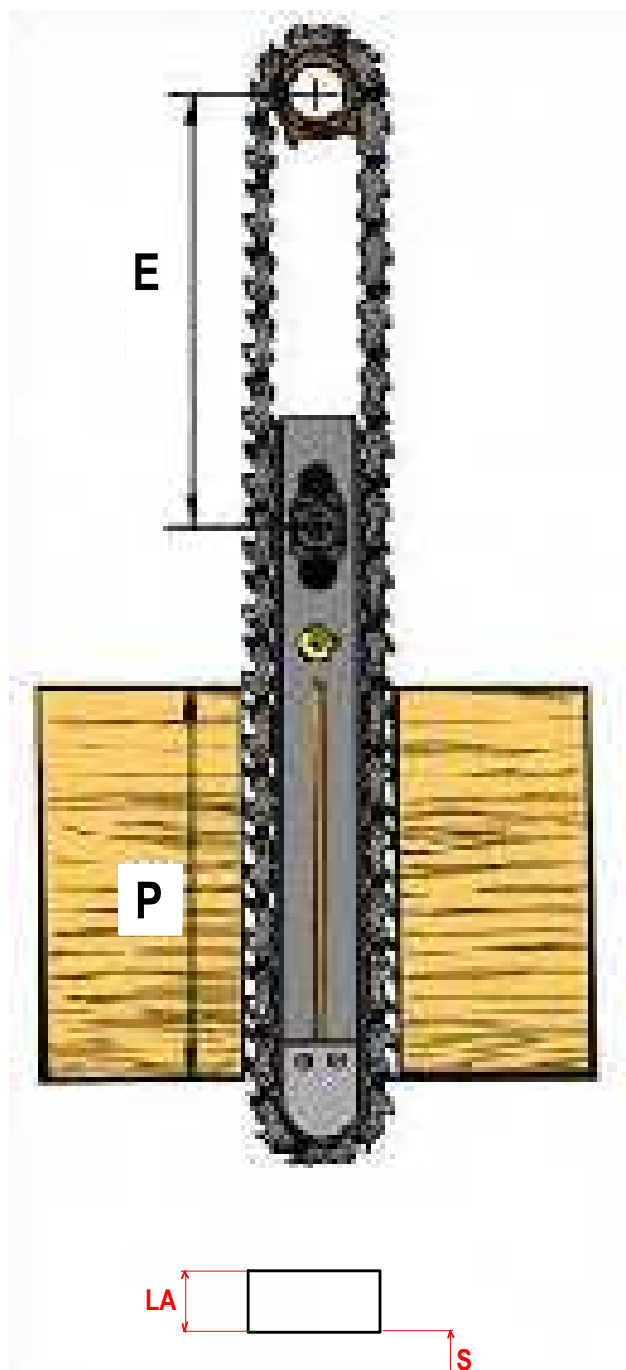

MOZZI - BUSSOLE - ANELLI

SLEEVES - REDUCING BUSHES - RINGS

MOZZI PER UTENSILI SLEEVES FOR TOOLS

Codice nr. HW	D. mm.	B mm.	d. mm.
M50/90	50	90	30-35-40
M50/100	50	100	30-35-40
M60/90	60	90	30-35-40-50
M60/100	60	100	30-35-40-50
MA60	60	50-110	50

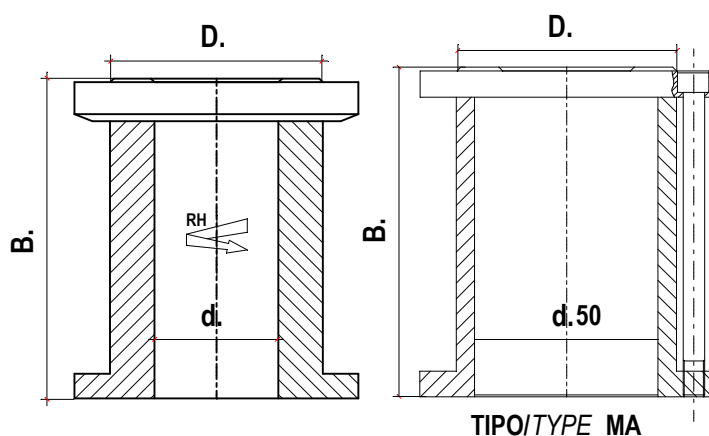

BUSSOLE DI RIDUZIONE CON GRADINO REDUCING BUSHES WITH COLLAR

Codice	D. mm.	d. mm.
3530G	35	30
3531G	35	31.75
4030G	40	30
4031G	40	31.75
4035G	40	35
5030G	50	30
5031G	50	31.75
5035G	50	35
5040G	50	40
6030G	60	30

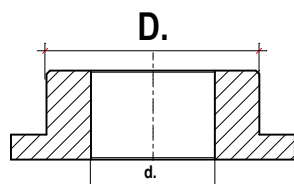

BUSSOLE DI RIDUZIONE REDUCING BUSHES

Codice	D. mm.	B mm.	d. mm.
1610	35-40	10	30-35
1615	35-40	15	30-35
1620	35-40	20	30-35
1630	35-40	30	30-35
3020	30	2	20
3025	30	2	25
3225	32	2	25
3230	32	2	30
3520	35	2	20
3525	35	2	25
3530	35	2	30

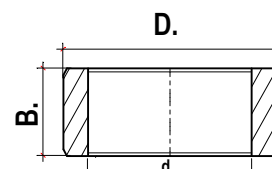

ANELLI RINGS

Codice	D. mm.	B mm.	d. mm.
15001	68-78	0.1	30-35-40-50-60
15003	68-78	0.3	30-35-40-50-60
15005	68-78	0.5	30-35-40-50-60
1501	68-78	1	30-35-40-50-60
1502	68-78	2	30-35-40-50-60
1503	68-78	3	30-35-40-50-60
1504	68-78	4	30-35-40-50-60
1505	68-78	5	30-35-40-50-60
1506	68-78	6	30-35-40-50-60
1507	68-78	7	30-35-40-50-60
1508	68-78	8	30-35-40-50-60
1510	68-78	10	30-35-40-50-60

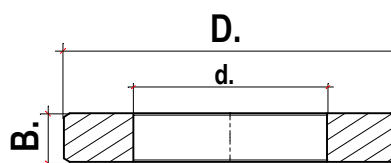

129 COLTELLI DA PIALLA

PLANING KNIVES - 13% Cr AND M2

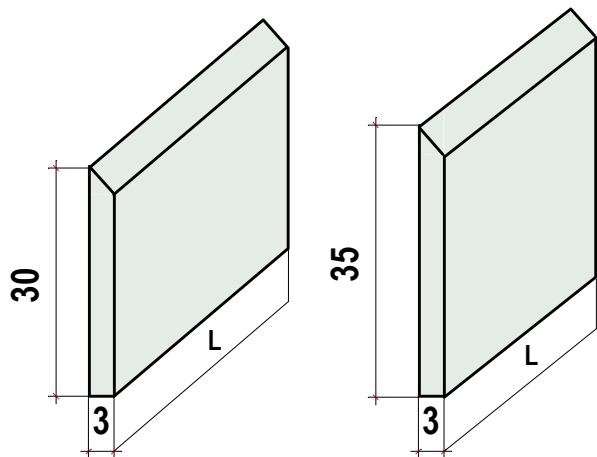

COLTELLI IN CONFEZIONI DA 2 o 4 PEZZI.
PER CALCOLARE IL PREZZO DI MISURE INTERMEDIE
FARE RIFERIMENTO ALLA LUNGHEZZA SUPERIORE.
MISURE INFERIORI A QUELLE DEL CATALOGO SU
RICHIESTA.

THE THIN KNIVES ARE PACKED WITH 2 OR 4 PCS.
TO CALCULATE PRICE OF INTERMEDIATE LENGHT
DIMENSIONS MAKE REFERENCE TO HIGHER
LENGHT.LOWER OR HIGHER LENGHT NOT IN
LIST:ON REQUEST.

129A 13%Cr

Codice	L mm.	B mm.	S mm.
129A30	300	30	3
129A35	350	30	3
129A40*	400	30	3
129A43	430	30	3
129A50*	500	30	3
129A53	530	30	3
129A60*	600	30	3
129A63	630	30	3
129A70*	700	30	3
129A30N	300	35	3
129A35N	350	35	3
129A40N*	400	35	3
129A43N	430	35	3
129A50N*	500	35	3
129A53N	530	35	3
129A60N*	600	35	3
129A63N	630	35	3
129A70N*	700	35	3

* SEMPRE DISPONIBILI A MAGAZZINO

* ALWAYS IN STOCK

129S HSS 18%W

Codice	L mm.	B mm.	S mm.
129S30	300	30	3
129S35	350	30	3
129S40*	400	30	3
129S43	430	30	3
129S50*	500	30	3
129S53	530	30	3
129S60*	600	30	3
129S63	630	30	3
129S70*	700	30	3
129S30N	300	35	3
129S35N	350	35	3
129S40N*	400	35	3
129S43N	430	35	3
129S50N*	500	35	3
129S53N	530	35	3
129S60N*	600	35	3
129S63N	630	35	3
129S70N*	700	35	3

* SEMPRE DISPONIBILI A MAGAZZINO

* ALWAYS IN STOCK

A RICHIESTA COLTELLI IN HW
ON REQUEST HW KNIVES

COLTELLI DA PIALLA REVERSIBILI HSS HW

REVERSIBLE HSS AND HW PLANING KNIVES

HSS 18%

CENTROLOCK SYSTEM

HQB WQB

CODICE		Dimensioni
HSS	HW	L x 16 x 3
HQB100	WQB100	100x16x3
HQB120	WQB120	120x16x3
HQB130	WQB130	130x16x3
HQB150	WQB150	150x16x3
HQB180	WQB180	180x16x3
HQB210	WQB210	210x16x3
HQB230	WQB230	230x16x3
HQB250	WQB250	250x16x3

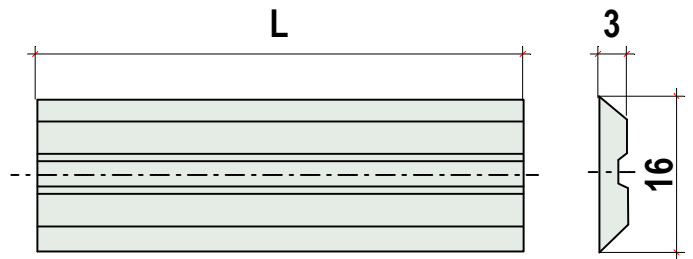

HQB = COLTELLI HSS-KNIVES HSS

WQB = COLTELLI HW-KNIVES HW

MISURE SPECIALI SU RICHIESTA
SPECIAL SIZES ON REQUEST

TERSA SYSTEM

HTR WTR

CODICE		Dimensioni
HSS	HW	L x 10 x 2.3
HTR100	WTR100	100x10x2.3
HTR120	WTR120	120x10x2.3
HTR130	WTR130	130x10x2.3
HTR150	WTR150	150x10x2.3
HTR180	WTR180	180x10x2.3
HTR210	WTR210	210x10x2.3
HTR230	WTR230	230x10x2.3
HTR250	WTR250	250x10x2.3

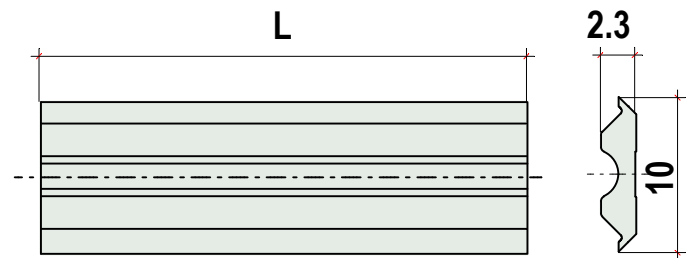

HTR= COLTELLI HSS-KNIVES HSS

WTR= COLTELLI HW-KNIVES HW

MISURE SPECIALI SU RICHIESTA
SPECIAL SIZES ON REQUEST

CENTROFIX SYSTEM

HCX WCX

CODICE		Dimensioni
HSS	HW	L x 12 x 2.7
HCX100	WCX100	100x12x2.7
HCX120	WCX120	120x12x2.7
HCX130	WCX130	130x12x2.7
HCX150	WCX150	150x12x2.7
HCX180	WCX180	180x12x2.7
HCX210	WCX210	210x12x2.7
HCX230	WCX230	230x12x2.7
HCX250	WCX250	250x12x2.7

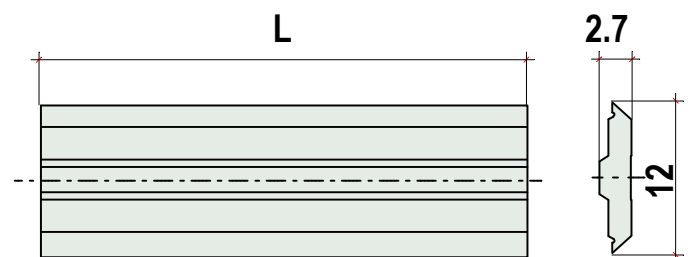

HCX= COLTELLI HSS-KNIVES HSS

WCX= COLTELLI HW-KNIVES HW

MISURE SPECIALI SU RICHIESTA
SPECIAL SIZES ON REQUEST

125 COLTELLI RIGATI HSS 18%

CORRUGATED KNIVES -HSS QUALITY

COLTELLI IN HSS SPESSORE 8 mm
COLTELLI PROFILATI A RICHIESTA

SOLID HSS QUALITY 8 mm.

THICKNESS BLANK KNIVES WITH PRECISION
GROUND SERRATED BACK TO USE WITH FINK
PROFILE CUTTER HEADS ART.124

STEP 1.587 mm

PROFILED KNIVES ON REQUEST

125

Codice	B	H	S	T. MAX
	mm.	mm.	mm.	mm.
125 040	40	50	8	17
125 060	60	50	8	17
125 080	80	50	8	17
125 100	100	50	8	17
125 130	130	50	8	17
125 150	150	50	8	17
125 180	180	50	8	17
125 230	230	50	8	17
125 650	650	50	8	17

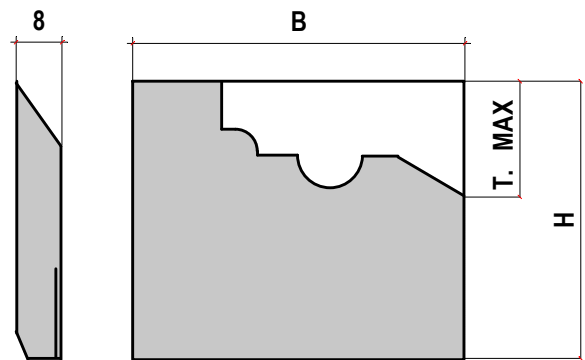

COLTELLI PROFILATI A RICHIESTA
PROFILED KNIVES ON REQUEST

125 A

Codice	B	H	S	T. MAX
	mm.	mm.	mm.	mm.
125 040 A	40	60	8	25
125 060 A	60	60	8	25
125 080 A	80	60	8	25
125 100 A	100	60	8	25
125 130 A	130	60	8	25
125 150 A	150	60	8	25
125 180 A	180	60	8	25
125 230 A	230	60	8	25
125 650 A	650	60	8	25

125 B

Codice	B	H	S	T. MAX
	mm.	mm.	mm.	mm.
125 040 B	40	70	8	32
125 060 B	60	70	8	32
125 080 B	80	70	8	32
125 100 B	100	70	8	32
125 130 B	130	70	8	32
125 150 B	150	70	8	32
125 180 B	180	70	8	32
125 230 B	230	70	8	32
125 650 B	650	70	8	32

COLTELLI HW STANDARD

HW STANDARD KNIVES

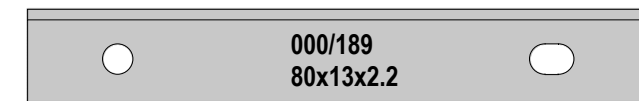
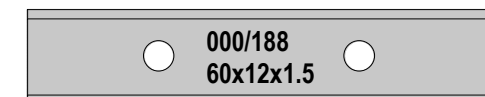
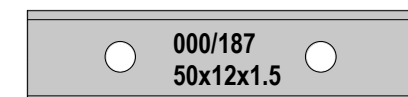
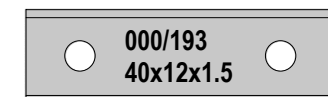
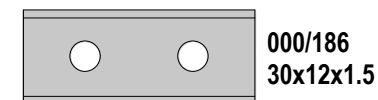
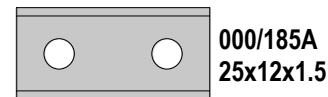
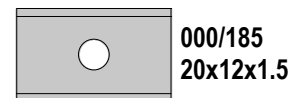
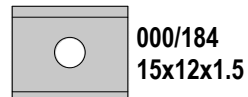
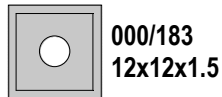
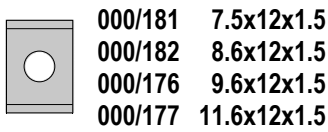

RASANTI-SPURS

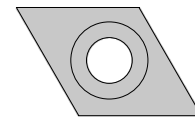
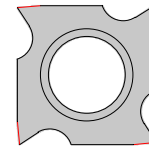
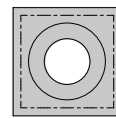

COLTELLI SMUSSATI

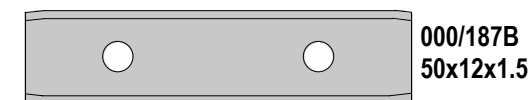
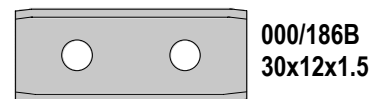
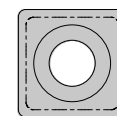
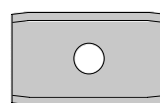

COLTELLI INCLINATI

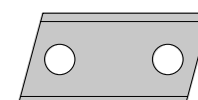
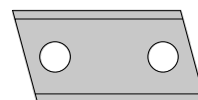
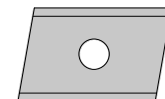
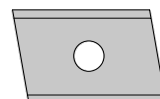

A RICHIESTA COLTELLI AFFILATI SU 4 LATI
ON REQUEST SHARPENED KNIVES ON ALL SIDES

INSERTI SPECIALI

HW SPECIAL KNIVES

RAGGIATORI

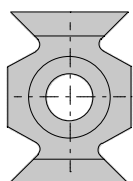

000/194	45°	22x16x5
000/195R1	R1.5	22x16x5
000/195R2	R2	22x16x5
000/195R3	R3	22x16x5
000/195R4	R4	22x16x5
000/195R5	R5	22x16x6

RAGGIATORI MAN

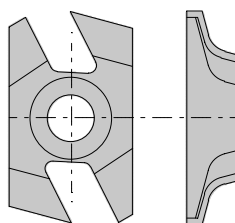

SPIGOLATORI REGOLABILI COMPLETE CHAMFERS SECTOR

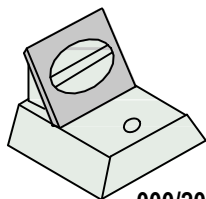

000/200 DX/RH

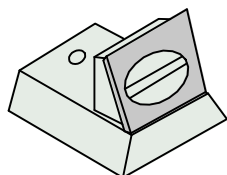

000/203 SX/LH

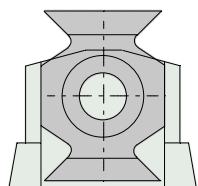

000/214

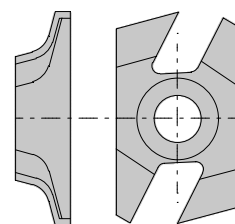

SETTORI PER INCASTRI GROOVE SECTORS

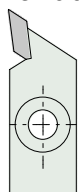

DX RH

000/G3D	3 mm
000/G3.5D	3.5 mm
000/G4D	4 mm
000/G5D	5 mm



SX LH

000/G3S	3 mm
000/G3.5S	3.5 mm
000/G4S	4 mm
000/G5S	5 mm

SETTORI PER INCASTRI MAN GROOVE SECTORS MAN

SETTORI ROMPIGOCCIA

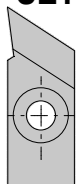

000/210 IG

INSERTI HW HW INSERTS

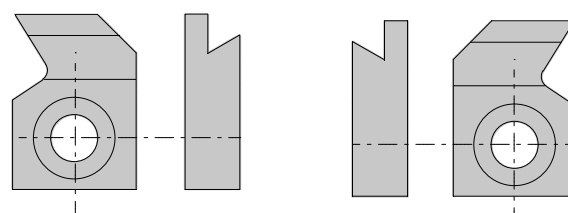
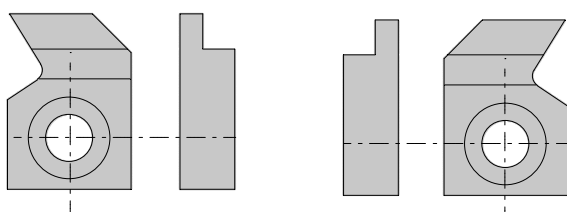

RICAMBI E ACCESSORI - SPARE PARTS

VITI E GRANI SCREWS



000/001 VITE TORX PER 4 mm
000/004 VITE TORX PER 5-6 mm

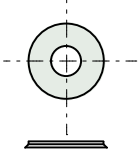

000/002 DADO PER RASANTE

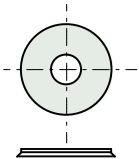

000/003 DADO PER SPESSORE B=4 mm
000/005 DADO PER SPESSORE B=5 mm
000/006 DADO PER SPESSORE B=6 mm

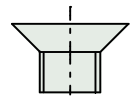

000/016 VITE RASANTE M5x6
SPUR SCREW
000/018 VITE RASANTE M5x8
SPUR SCREW
000/020 VITE IG M5x10
SCREW

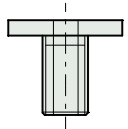

000/021 VITE REGOLAZIONE M6x12.5
REGULATION SCREW

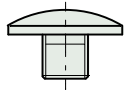

000/024 VITE M5 PER 5/47
SECURITY SCREW

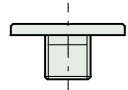

000/025 VITE M5 PER RIFERIMENTO

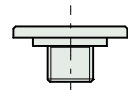

000/026 VITE M5 PER RIFERIMENTO

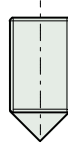

000/022 GRANO M4x20
000/011 GRANO M5x10
000/012 GRANO CON SFERA
M5x12

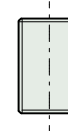

000/010 GRANO M5x6

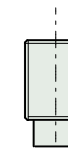

000/009A GRANO M5x15
000/007 GRANO M8x12
000/008 GRANO M8x15
000/008A GRANO M10x15
000/008B GRANO M10x20
000/008C GRANO M10x25

CHIAVI WRENCH

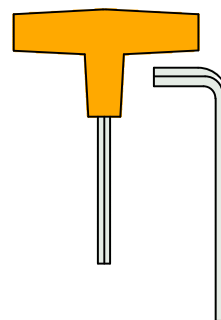

000/030 CHIAVE ESAG. 2 mm
EXAGONAL WRENCH
000/031 CHIAVE ESAG. 2.5 mm
EXAGONAL WRENCH
000/031A CHIAVE ESAG. 3 mm
EXAGONAL WRENCH
000/032 CHIAVE ESAG. 4 mm
EXAGONAL WRENCH
000/034 CHIAVE ESAG. 5 mm
EXAGONAL WRENCH

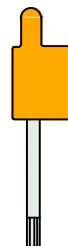

000/037 CHIAVE TORX T9
TORX WRENCH
000/039 CHIAVE TORX T20
TORX WRENCH

000/040 CHIAVE PER MOZZI
SLEEVE WRENCH

RICAMBI STANDARD - STANDARD PARTS

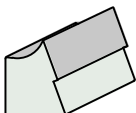
CODICE CODE	DESCRIZIONE / DESCRIPTION	PAG. PAGE
	CUNEI PER COLTELLI DIRITTI	
000/160	C7 CUNEO PERIWEDGE FOR B=8 mm	
000/150	C8 CUNEO PERIWEDGE FOR B=9-10 mm	
000/151	C10 CUNEO PERIWEDGE FOR B=12 mm	
000/152	C14 CUNEO PERIWEDGE FOR B=15-16 mm	
000/164	C16 CUNEO PERIWEDGE FOR B=20 mm AXIAL	
000/153	C18 CUNEO PERIWEDGE FOR B=20 mm	
000/162	C21 CUNEO PERIWEDGE FOR B=25 mm AXIAL	
000/165	C26 CUNEO PERIWEDGE FOR B=30 mm AXIAL	
000/154	C28 CUNEO PERIWEDGE FOR B=30 mm	
000/163	C36 CUNEO PERIWEDGE FOR B=40 mm AXIAL	
000/166	C46 CUNEO PERIWEDGE FOR B=50 mm AXIAL	
000/155	C48 CUNEO PERIWEDGE FOR B=50 mm	
000/167	C56 CUNEO PERIWEDGE FOR B=60 mm AXIAL	
000/156	C58 CUNEO PERIWEDGE FOR B=60 mm	
000/157	C78 CUNEO PERIWEDGE FOR B=80 mm	

000/137/16	CUNEO IWEDGE 16 mm 5/VE	
000/137/26	CUNEO IWEDGE 26 mm 5/VE	
000/137/48	CUNEO IWEDGE 48 mm 5/50R 5/50S	

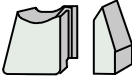

000/140	C7 CUNEO PERIWEDGE FOR B=8 mm	
000/141	C7 CUNEO PERIWEDGE FOR B=8 mm	

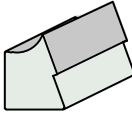
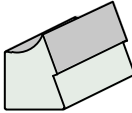
CUNEI PER COLTELLI PROFILATI H=12 mm

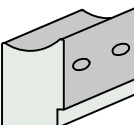
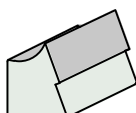
000/143	C18 CUNEO IWEDGE 18 mm 5/47A	
000/145	C48 CUNEO IWEDGE 48 mm 5/47A	
000/142	C18 CUNEO IWEDGE 18 mm 5/47B	
000/144	C48 CUNEO IWEDGE 48 mm 5/47B	
000/147	C48 CUNEO IWEDGE 48 mm 5/47SA	
000/148	C48 CUNEO IWEDGE 48 mm 5/47SB	
C45	C58 CUNEO IWEDGE 58 mm 5/45	
C57	CUNEO IWEDGE 48 mm 5/57	

CODICE CODE	DESCRIZIONE / DESCRIPTION	PAG. PAGE
	CUNEI PER COLTELLI PROFILATI	
C27	C10 CUNEO PERIWEDGE FOR 5/27	
C42	C10 CUNEO PERIWEDGE FOR 5/42	
139/10	CUNEO PERIWEDGE FOR B=12 mm	
139/13	CUNEO PERIWEDGE FOR B=15 mm	
139/18	CUNEO PERIWEDGE FOR B=20 mm	
139/23	CUNEO PERIWEDGE FOR B=25 mm	
139/28	CUNEO PERIWEDGE FOR B=30 mm	
139/33	CUNEO PERIWEDGE FOR B=35 mm	
139/38	CUNEO PERIWEDGE FOR B=40 mm	
139/48	CUNEO PERIWEDGE FOR B=50 mm	
139/58	CUNEO PERIWEDGE FOR B=60 mm	
149/28	CUNEO PERIWEDGE FOR 5/52 R4-5	
149/48	CUNEO PERIWEDGE FOR 5/56-50	
149/58	CUNEO PERIWEDGE FOR 5/56-60	
149/61-6	CUNEO IWEDGE 58 mm 5/61-60	
149/61-8	CUNEO IWEDGE 78 mm 5/61-80	
149/66	CUNEO PERIWEDGE FOR 5/66	

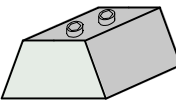
CUNEI PER TESTE PORTACOLTELLI

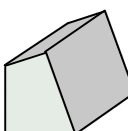
000/138B	CUNEO IWEDGE 38 mm art.103	
138/48	CUNEO IWEDGE 48 mm art.105	
000/138BG	CUNEO IWEDGE 38 mm art.102	
138/48BG	CUNEO IWEDGE 48 mm art.104	
138/40BG	CUNEO IWEDGE 40 mm art.106	
138/L....	CUNEO PER IWEDGE FOR art.124-131	
158/L....	CUNEO PER IWEDGE FOR art.QUICKBLOCK	

MANUTENZIONE UTENSILI

MAINTENANCE TOOLS



LA PULIZIA DEGLI UTENSILI CON ULTRASUONI E' SENZA DUBBIO IL MODO PIU' RAPIDO ED EFFICACE PER ELIMINARE LE INCROSTAZIONI .
DISPONIBILE LIQUIDO DISINCROSTANTE PER ACCIAIO O PER ALLUMINIO

THE CLEANING OF THE TOOLS WITH ULTRASOUND IS THE MOST RAPID AND EFFECTIVE WAY TO REMOVE THE INCRUSTATIONS.

FLUID DESCALER FOR STEEL OR ALUMINIUM IS AVAILABLE.

UTC LAVAPEZZI AD ULTRASUONI ULTRASONIC TOOL CLEANER

Codice nr.	DIM. ESTERNE OVERALL SIZE	DIM. VASCA INTERNAL SIZE	PESO WEIGHT
	L x P x H cm.	L x P x H cm.	Kg
UTC 12	34 x 27 x 39	30 x 23 x 20	10
UTC 28	53 x 33 x 40	50 x 29 x 20	20
UTC 35	47 x 32 x 54	40 x 25 x 35	25

DU PRODOTTO DISINCROSTANTE FLUID DESCALER

Codice nr.	VOL. LITRI
DU 1	1
DU 5	5



MT ATTREZZO PER SMONTAGGIO GRUPPI MAINTENANCE TOOL FOR CUTTERHEAD SETS

Codice nr.

MT 1





FINK s.r.l.
Via G.Giusti 15
20900 Monza - MB
tel: +39 - 039 - 386961
tel: +39 - 039 - 386962
fax: +39 - 039 - 361458
e-mail: fink@finktools.com
www.finktools.com

