



Universal-Cutterhead Euro Catalog

with Profile knife / Deflector

UFC 2023





WHY STEHLE

Stehle - Reliable

For over 100 years Stehle has delivered worldwide, to both consumers and the commercial market technically precise machine tools. Stehle is known for its high precision and economical cutter heads for processing of solid wood.

Stehle - a quality product with a clear market vision

Optimal price-performance. A high-quality tool.

Behind the Stehle brand lies a worldwide professional sales and production network.

Stehle - the optimal partner for trade

We have many items in stock for you and your customers.

In addition, many tools which are not in the catalogue are often available from stock.

Or can be manufactured to your specific requirements

Stehle - continually strives to improve

Quality and safety remain the top priority for the Stehle group and through ISO certification and product improvement this will always be ensured.

Stehle - a good and extensive program

With circular saw blades, router cutters, finger joint cutters, reversible knife cutters, drills,

CNC tooling, diamond and hand tools, we have a very comprehensive product range.

Our production methods, and knowledge are maintained at the highest level due to our extensive training programs.

We are always at your service for any questions that may arise!

Your Stehle-Team

TABLE OF CONTENTS

Universal Cutterheads Euro		Page
Standard version in steel (MAN)		4
Standard version in steel (MAN) including knives delivered as sets		5
Profil knives 40 mm width		
Folding knives	16/20/24 x 4 mm	6
Profile knives / deflector 001 t/m 099	40 x 4 mm	6 - 12
Profile knives / deflector 100 t/m 177	40 x 4 mm	13 - 15
Profile knives 50 mm width		
Profile knives / deflector 500 t/m 580	50 x 4 mm	16 - 20
Profile knives 50 mm width		
Profile knives / deflector 200 t/m 233	50 x 5,5 mm	21 - 23
Knife blanks		
Knife blanks 40 mm		23
Knife blanks 50 mm		23
Knife blanks 60 mm		23
Packing unit		
Profile knives:	PU = 2	
Knife blanks:	Pu = 6	
Prices per piece		

SP Universal Cutterheads Euro
Standard

Produkt

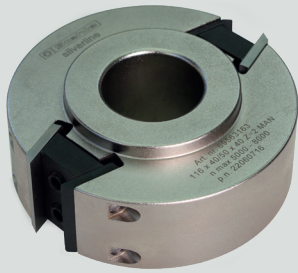

Design



BG-TEST
016-058

silverline

MAN

Machine / Application

- table shapers (manual feed)
- for profiling of soft and hard woods (solid wood, not glued)

Design

- tool body made from steel
- knives made of SP steel
- incl folding knives and deflectors
- incl. pressure pad, screw and wrench

Advantages

- Stehle has different tool sets in the programme Page 5

Notes

- **Machining Information:**
Always install profile knives with matching deflector !
- Only knives and deflectors 40 x 4 mm may be installed in cutter head 69563162. In the remaining cutterheads, knives and deflectors 40 x 4 mm and 50 x 4 mm).
- **Knife and deflector thickness 4 mm other thicknesses not permitted**

Product features

Order information

Ø D [mm]	B [mm]	Ø d [mm]	Z	PU [pc.]	Order-No.
096	40	30	2 + 2	1	69563162
116	40/50	30	2 + 2	1	69563160
116	40/50	40	2 + 2	1	69563163
116	40/50	50	2 + 2	1	69563161

Wood



SP Universal Cutterheads Euro
SETS

Product

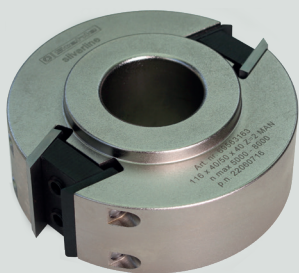

Design



Machine / Application

- table shapers (manual feed)
- for profiling of soft and hard woods (solid wood, not glued)

Design

- tool body made from steel
- knives made of SP steel
- incl folding knives and deflectors
- incl. pressure pad, screw and wrench

Advantages

- Cutter head with built-in knife and deflector and key included in delivery
- Stehle offers different tool sets with the profile of 1-6, 1-12, 1-24, 1-36, delivered in a wooden tool box

Notes

- **Machining Information:** Always install profile knives with matching deflector !
- Only knives and deflectors 40 x 4 mm may be installed in cutter head 69563162. In the remaining cutterheads, knives and deflectors 40 x 4 mm and 50 x 4 mm).
- Knife and deflector thickness 4 mm other thicknesses not permitted

Product features
SETS

Order information

Ø D [mm]	B [mm]	Ø d [mm]	Z	PU [pc.]	Order-No. 6-pieces	Order-No. 12-pieces	Order-No. 24-pieces	Order-No. 36-pieces
096	40	30	2 + 2	1	56316206	56316212	56316224	56316236
116	40/50	30	2 + 2	1	56316006	56316012	56316024	56316036
116	40/50	40	2 + 2	1	56316306	56316312	56316324	56316336
116	40/50	50	2 + 2	1	56316106	56316112	56316124	56316136



Wood

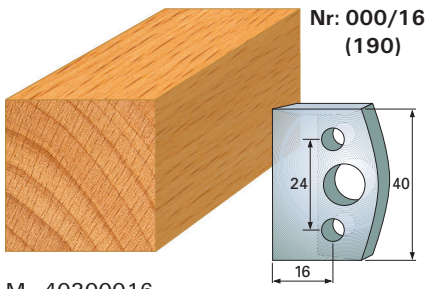

M 40300016
A 40320016

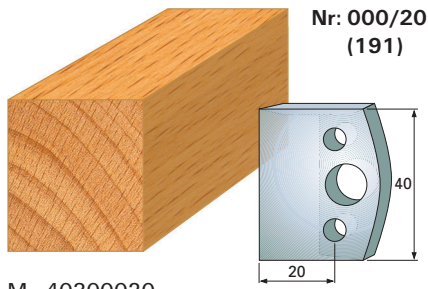

M 40300020
A 40320020

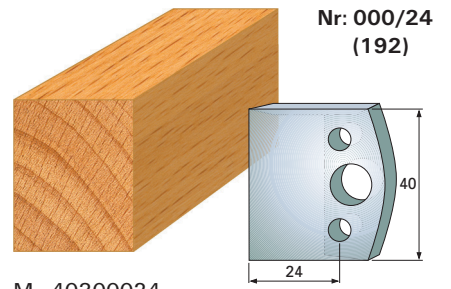

M 40300024
A 40320024

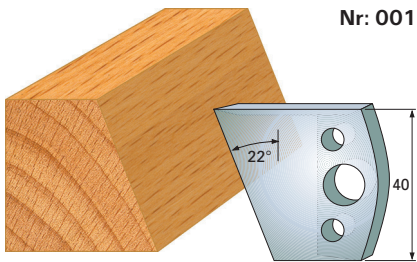

M 50403001
A 50403201

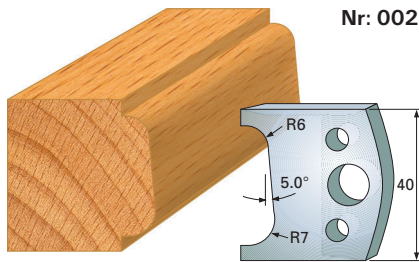

M 50403002
A 50403202

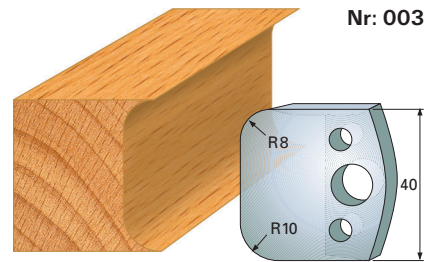

M 50403003
A 50403203

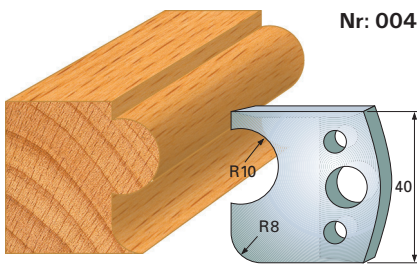

M 50403004
A 50403204

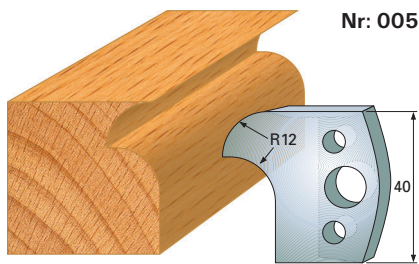

M 50403005
A 50403205

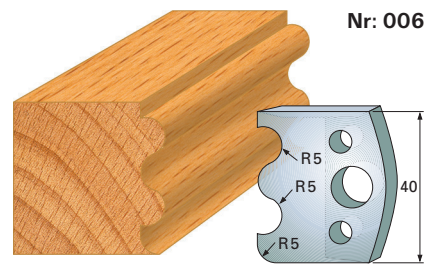

M 50403006
A 50403206

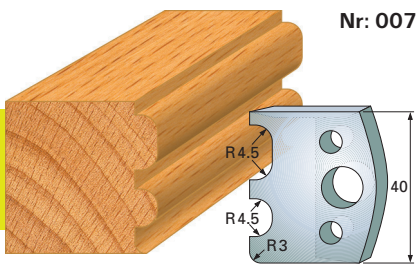

M 50403007
A 50403207

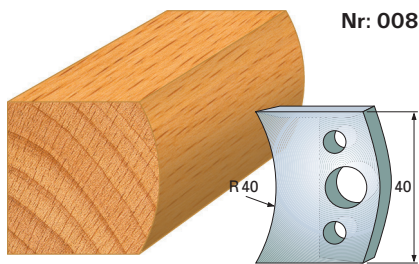

M 50403008
A 50403208

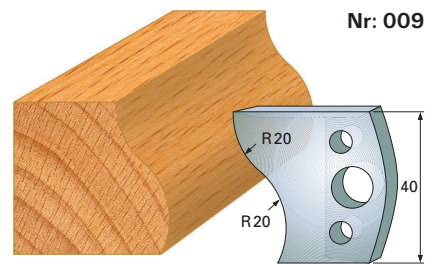

M 50403009
A 50403209

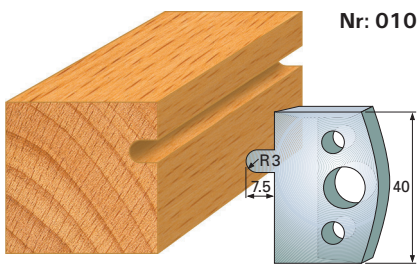

M 50403010
A 50403210

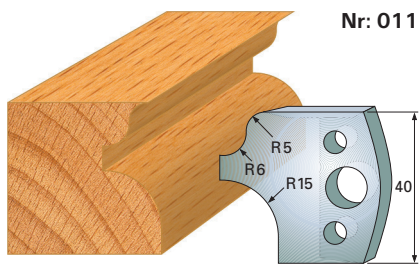

M 50403011
A 50403211

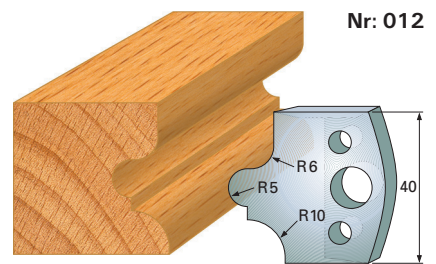

M 50403012
A 50403212

Wood

M = Profile knife A = Deflector *Product discontinued while stocks last

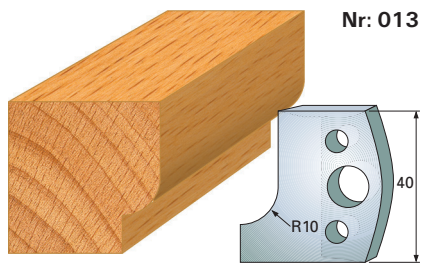

Nr: 013

M 50403013
A 50403213

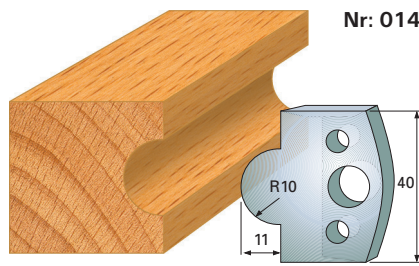

Nr: 014

M 50403014
A 50403214

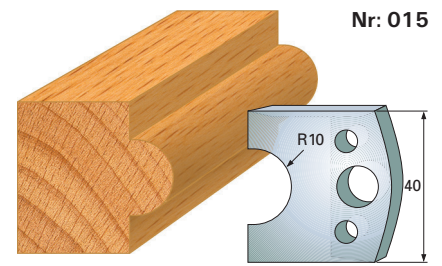

Nr: 015

M 50403015
A 50403215

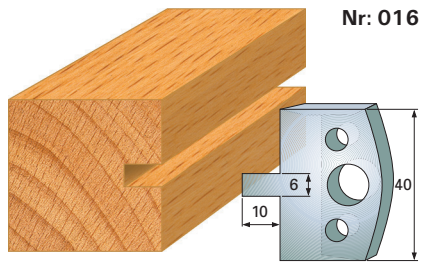

Nr: 016

M 50403016
A 50403216

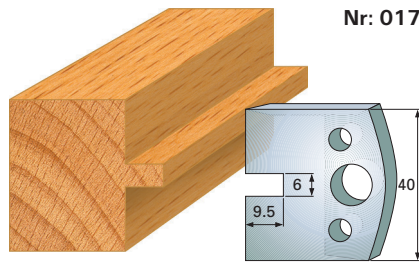

Nr: 017

M 50403017
A 50403217

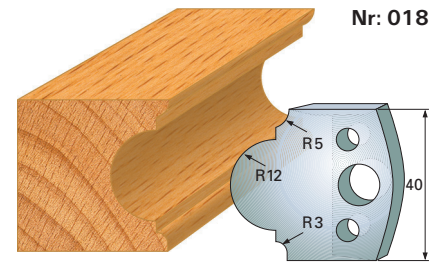

Nr: 018

M 50403018
A 50403218

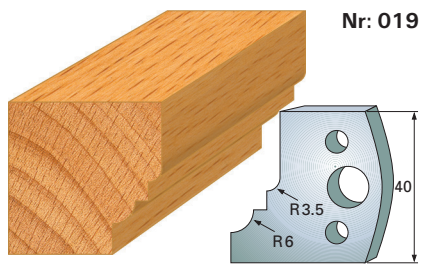

Nr: 019

M 50403019
A 50403219

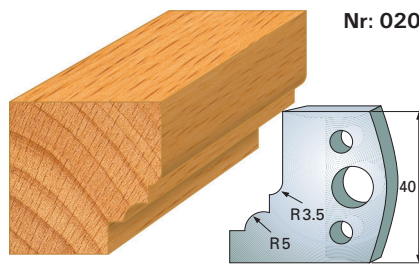

Nr: 020

M 50403020
A 50403220

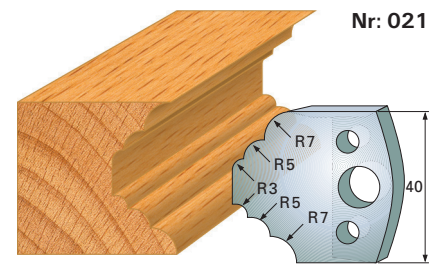

Nr: 021

M 50403021
A 50403221

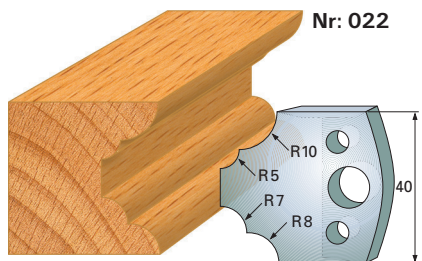

Nr: 022

M 50403022
A 50403222

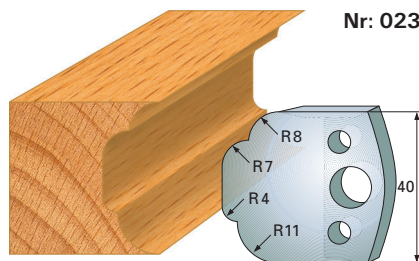

Nr: 023

M 50403023
A 50403223

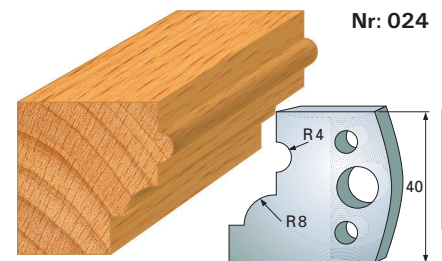

Nr: 024

M 50403024
A 50403224

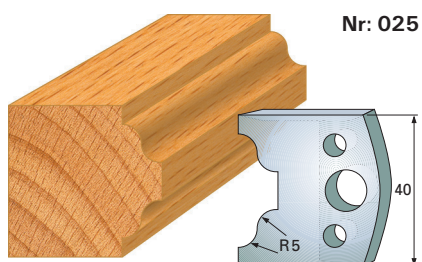

Nr: 025

M 50403025
A 50403225

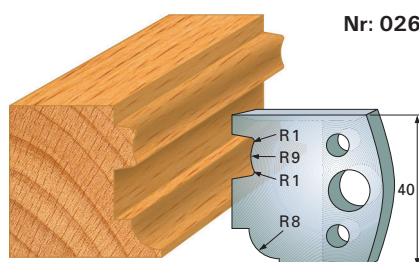

Nr: 026

M 50403026
A 50403226

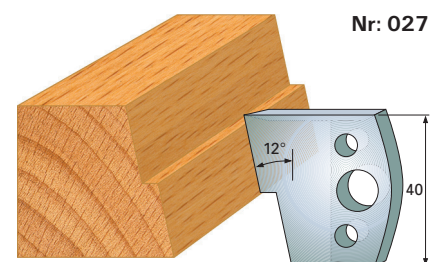

Nr: 027

M 50403027
A 50403227

Wood

M = Profile knife A = Deflector *Product discontinued while stocks last

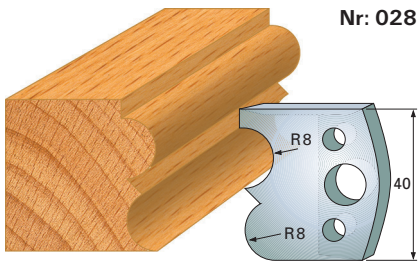

Nr: 028

M 50403028
A 50403228

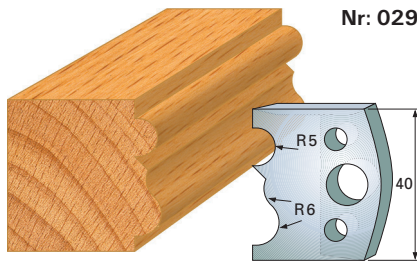

Nr: 029

M 50403029
A 50403229

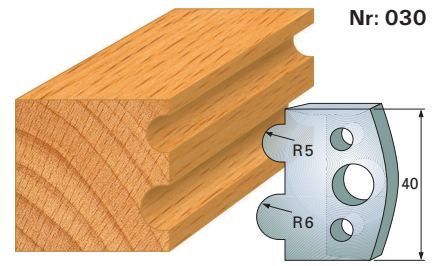

Nr: 030

M 50403030
A 50403230

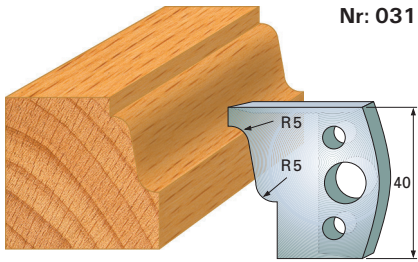

Nr: 031

M 50403031
A 50403231

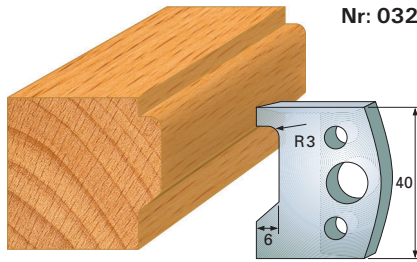

Nr: 032

M 50403032
A 50403232

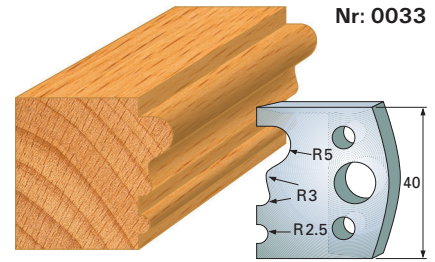

Nr: 0033

M 50403033
A 50403233

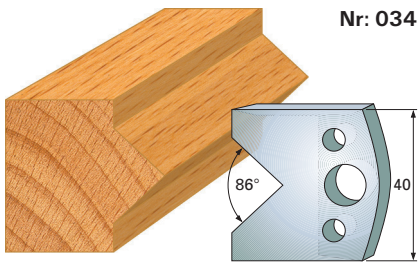

Nr: 034

M 50403034
A 50403234

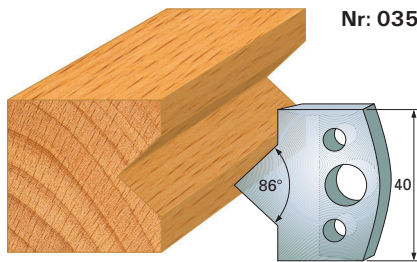

Nr: 035

M 50403035
A 50403235

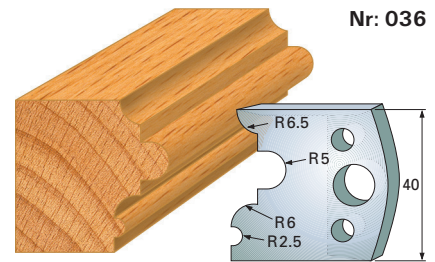

Nr: 036

M 50403036
A 50403236

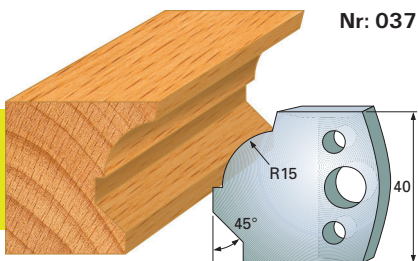

Nr: 037

M 50403037
A 50403237

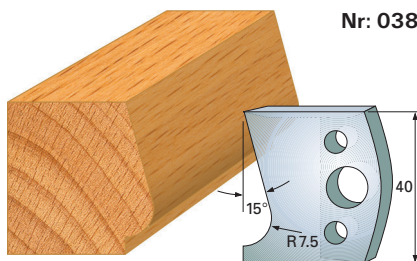

Nr: 038

M 50403038
A 50403238

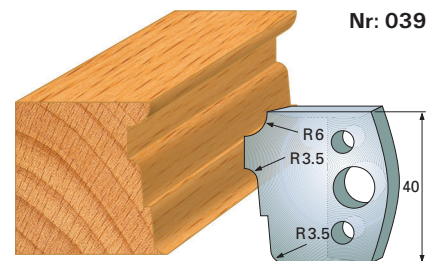

Nr: 039

M 50403039
A 50403239

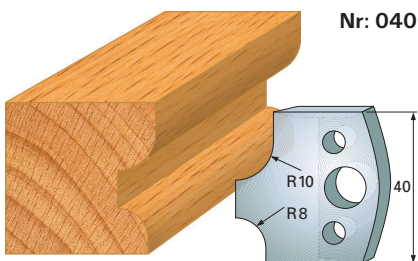

Nr: 040

M 50403040
A 50403240

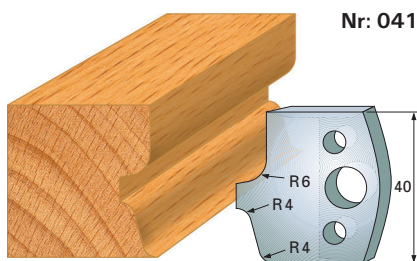

Nr: 041

M 50403041
A 50403241

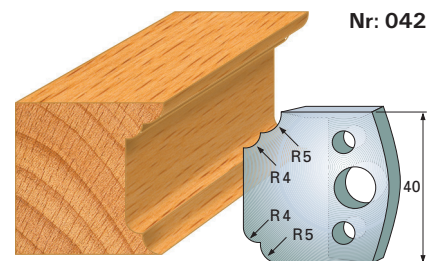

Nr: 042

M 50403042
A 50403242

Wood

M = Profile knife A = Deflector *Product discontinued while stocks last

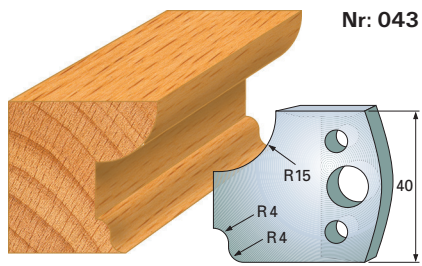

M 50403043
A 50403243

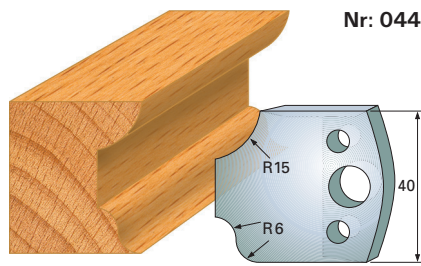

M 50403044
A 50403244

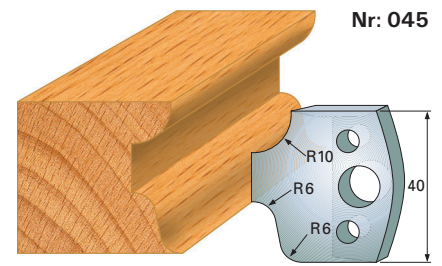

M 50403045
A 50403245

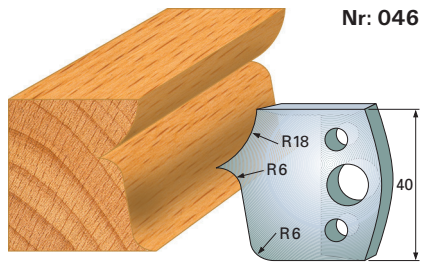

M 50403046
A 50403246

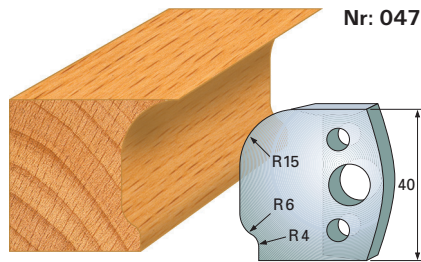

M 50403047
A 50403247

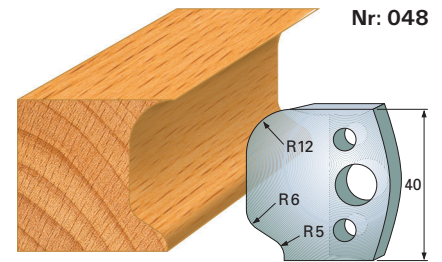

M 50403048
A 50403248

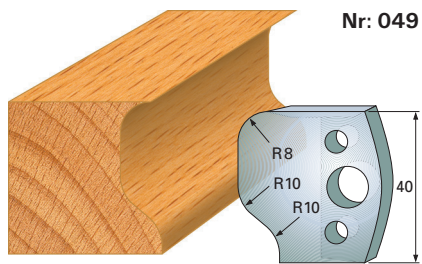

M 50403049
A 50403249

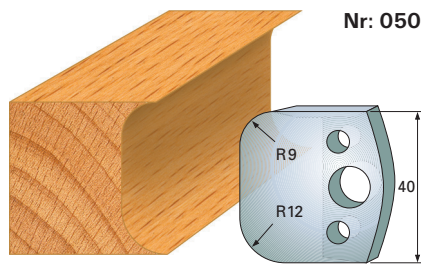

M 50403050
A 50403250

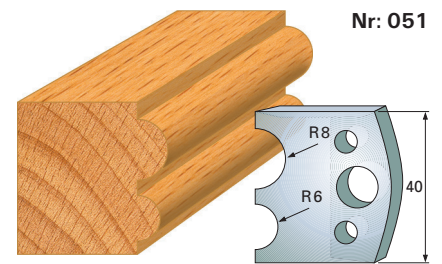

M 50403051
A 50403251

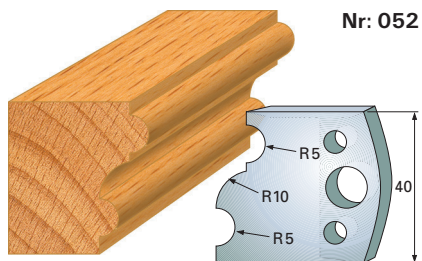

M 50403052
A 50403252

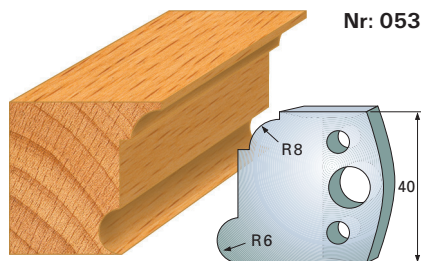

M 50403053
A 50403253

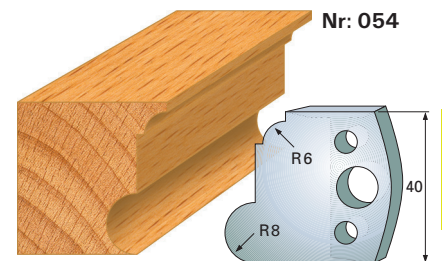

M 50403054
A 50403254

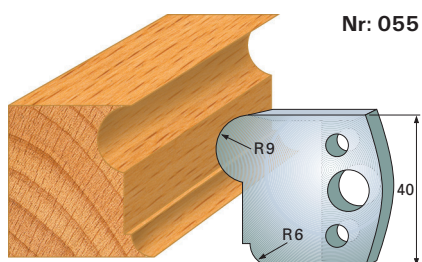

M 50403055
A 50403255

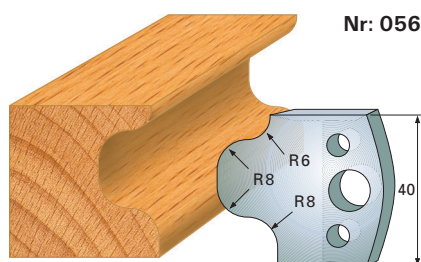

M 50403056
A 50403256

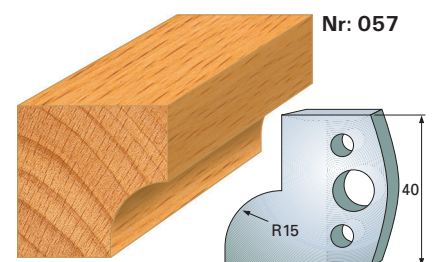

M 50403057
A 50403257

Wood

M = Profile knife A = Deflector *Product discontinued while stocks last

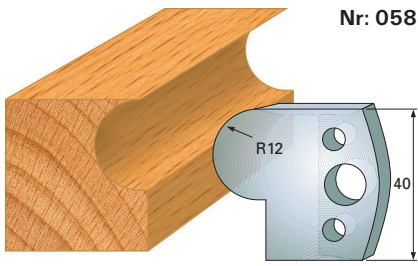

Nr: 058

M 50403058
A 50403258

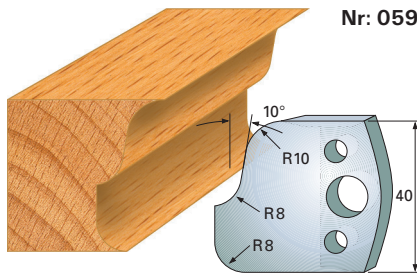

Nr: 059

M 50403059
A 50403259

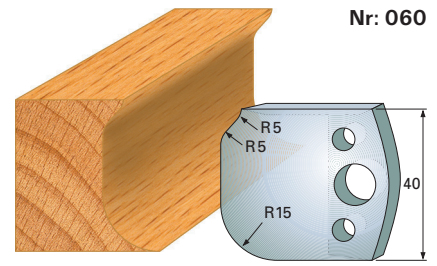

Nr: 060

M 50403060
A 50403260

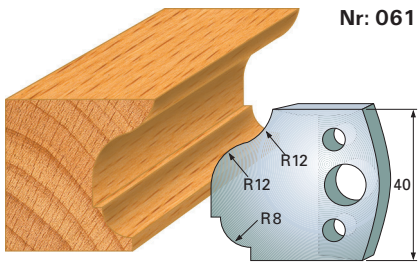

Nr: 061

M 50403061
A 50403261

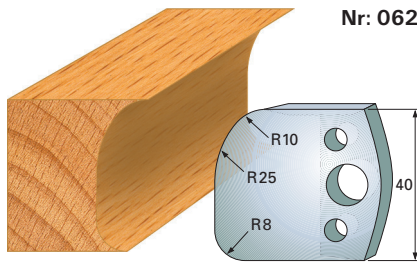

Nr: 062

M 50403062
A 50403262

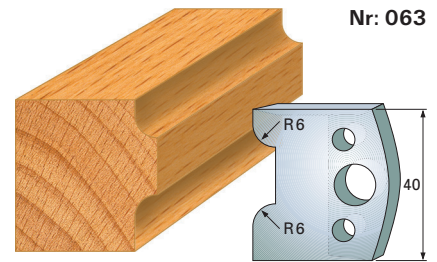

Nr: 063

M 50403063
A 50403263

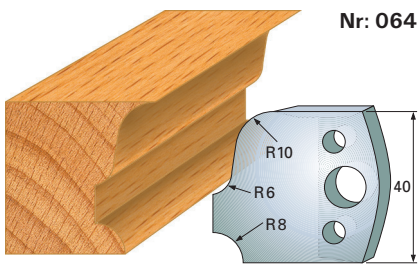

Nr: 064

M 50403064
A 50403264

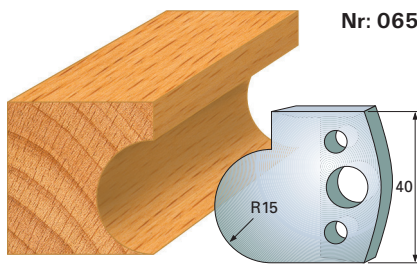

Nr: 065

M 50403065
A 50403265

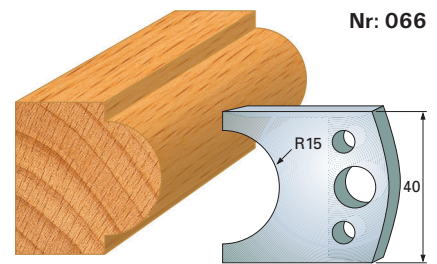

Nr: 066

M 50403066
A 50403266

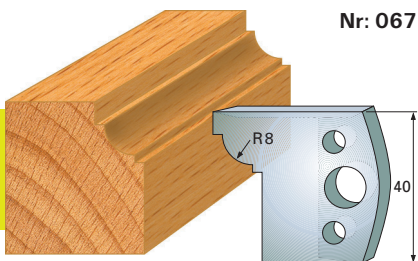

Nr: 067

M 50403067
A 50403267

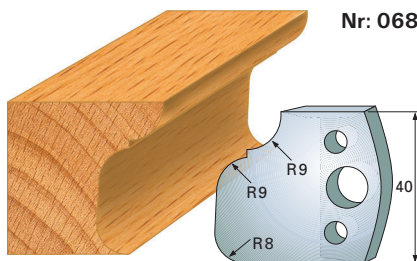

Nr: 068

M 50403068
A 50403268

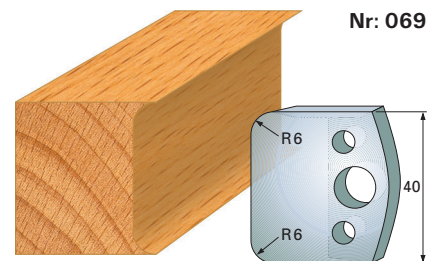

Nr: 069

M 50403069
A 50403269

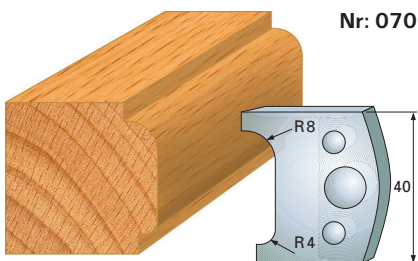

Nr: 070

M 50403070
A 50403270

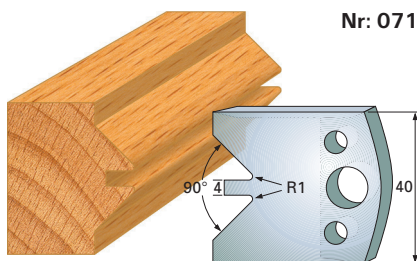

Nr: 071

M 50403071
A 50403271

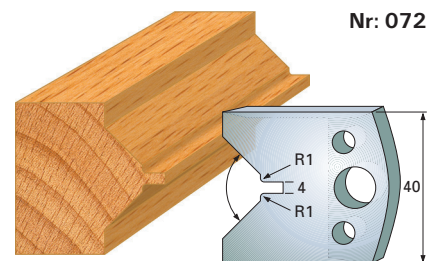

Nr: 072

M 50403072
A 50403272

M = Profile knife A = Deflector *Product discontinued while stocks last

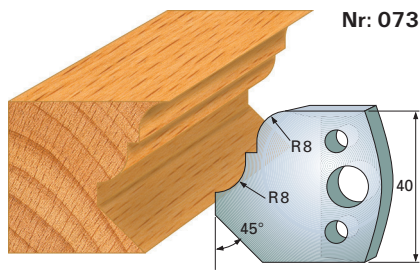

Nr: 073

M 50403073
A 50403273

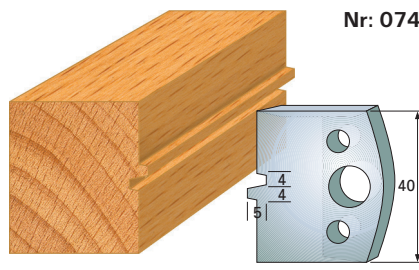

Nr: 074

M 50403074
A 50403274

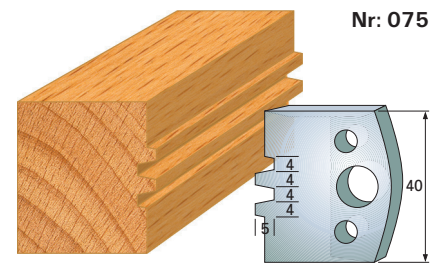

Nr: 075

M 50403075
A 50403275

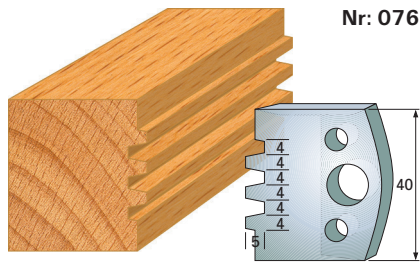

Nr: 076

M 50403076
A 50403276

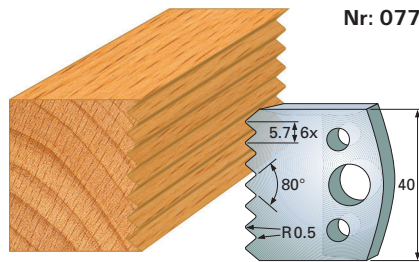

Nr: 077

M 50403077
A 50403277

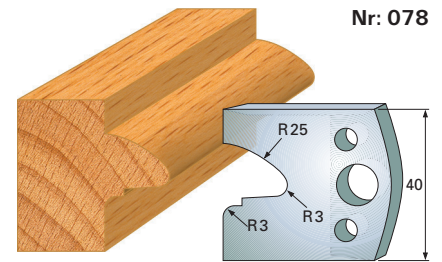

Nr: 078

M 50403078
A 50403278

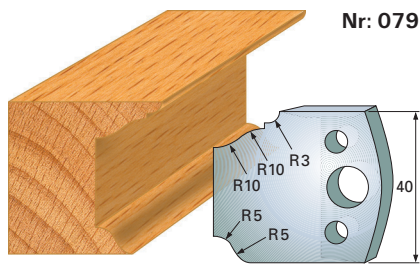

Nr: 079

M 50403079
A 50403279

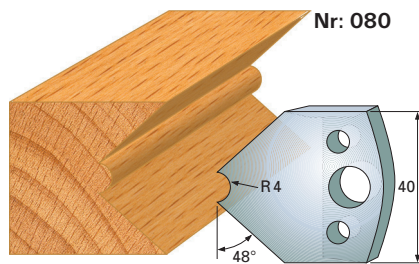

Nr: 080

M 50403080
A 50403280

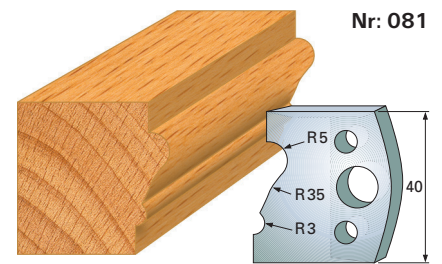

Nr: 081

M 50403081
A 50403281

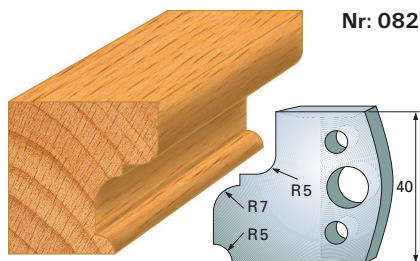

Nr: 082

M 50403082
A 50403282

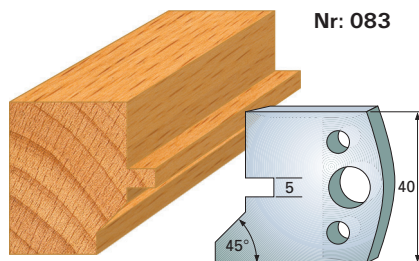

Nr: 083

M 50403083
A 50403283

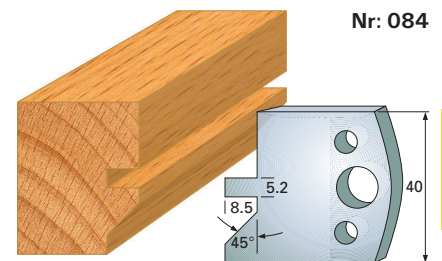

Nr: 084

M 50403084
A 50403284

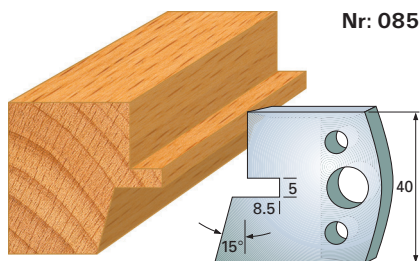

Nr: 085

M 50403085
A 50403285

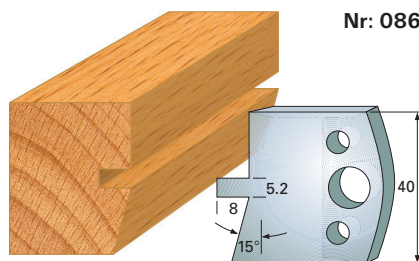

Nr: 086

M 50403086
A 50403286

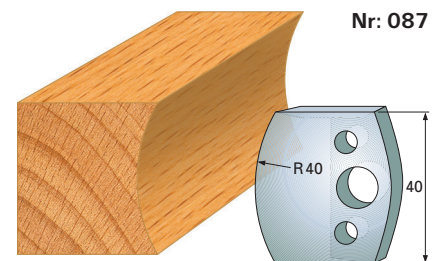

Nr: 087

M 50403087
A 50403287

Wood

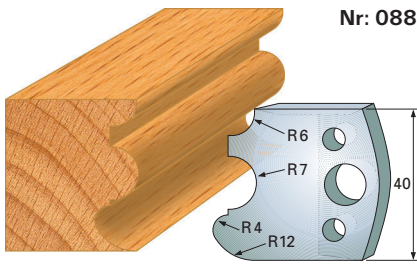

Nr: 088

M 50403088
A 50403288

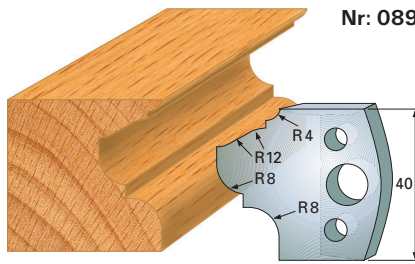

Nr: 089

M 50403089
A 50403289

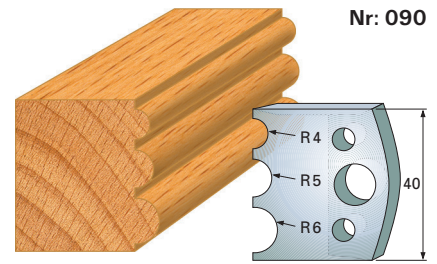

Nr: 090

M 50403090
A 50403290

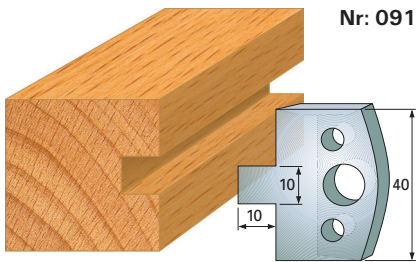

Nr: 091

M 50403091
A 50403291

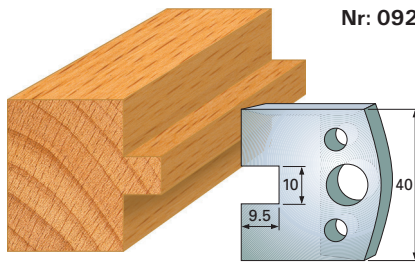

Nr: 092

M 50403092
A 50403292

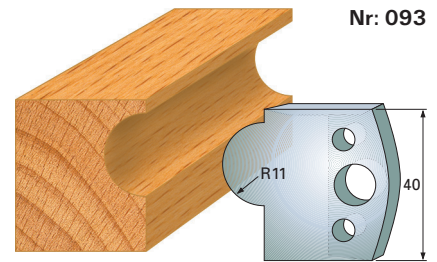

Nr: 093

M 50403093
A 50403293

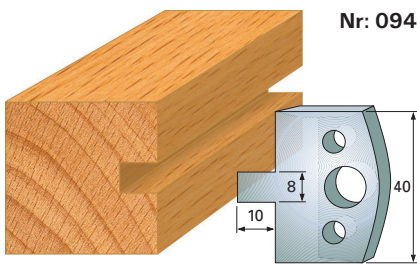

Nr: 094

M 50403094
A 50403294

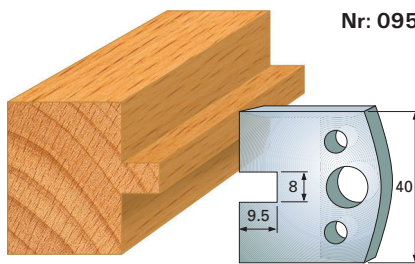

Nr: 095

M 50403095
A 50403295

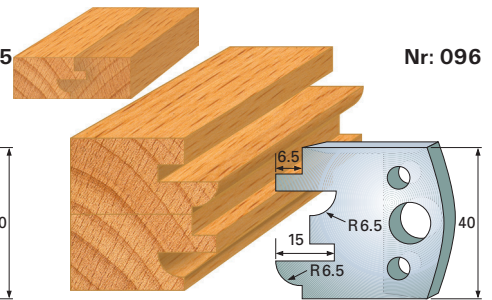

Nr: 096

M 50403096
A 50403296

Konterprofil K-1

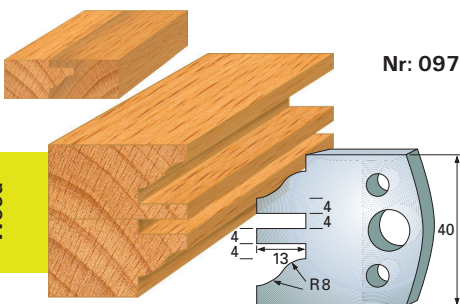

Nr: 097

M 50403097
A 50403297

Konterprofil K-2

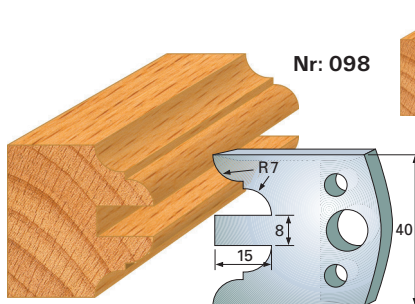

Nr: 098

M 50403098
A 50403298

Konterprofil K-3

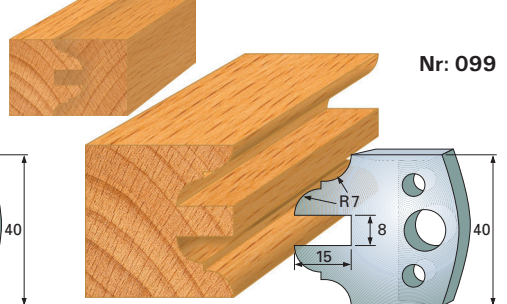

Nr: 099

M 50403099
A 50403299

Konterprofil K-4

Wood

Nr: 100

M 50403100
A 50403300

Abplattmesser

Nr: 101

M 50403101
A 50403301

Nr: 102

M 50403102
A 50403302

Nr: 103

M 50403103
A 50403303

Nr: 104

M 50403104
A 50403304

Nr: 105

M 50403105
A 50403305

Nr: 106

M 50403106
A 50403306

Nr: 107

M 50403107
A 50403307

Nr: 108

M 50403108
A 50403308

Nr: 109

M 50403109
A 50403309

Nr: 110

M 50403110
A 50403310

Nr: 111

M 50403111
A 50403311

Nr: 112

M 50403112
A 50403312

Nr: 113

M 50403113
A 50403313

Nr: 114

M 50403114
A 50403314

Wood

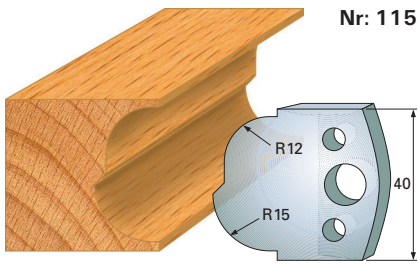

Nr: 115

M 50403115
A 50403315

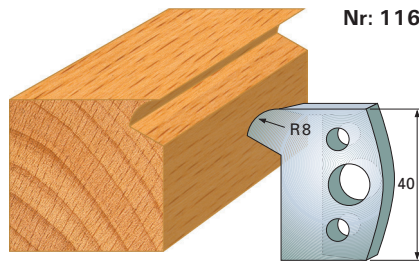

Nr: 116

M 50403116
A 50403316

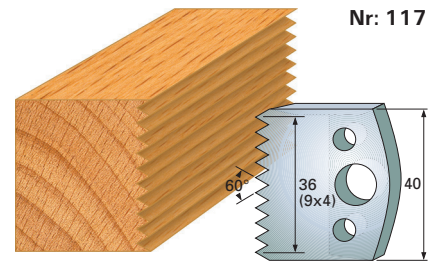

Nr: 117

M 50403117
A 50403317

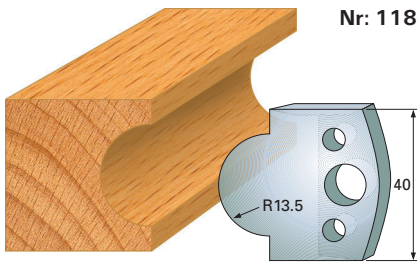

Nr: 118

M 50403118
A 50403318

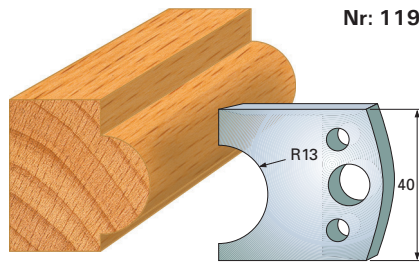

Nr: 119

M 50403119
A 50403319

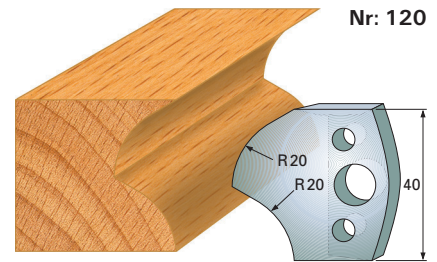

Nr: 120

M 50403120
A 50403320

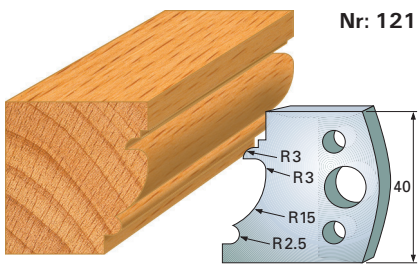

Nr: 121

M 50403121
A 50403321

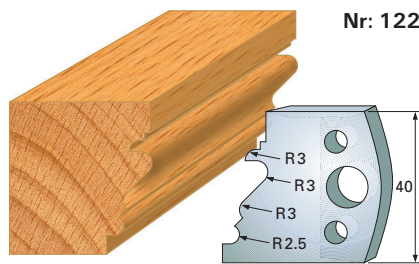

Nr: 122

M 50403122
A 50403322

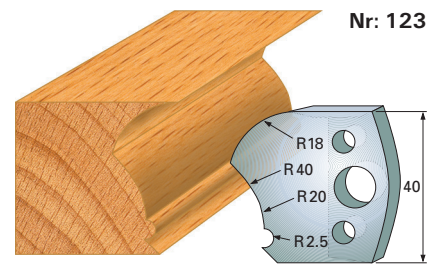

Nr: 123

M 50403123
A 50403323

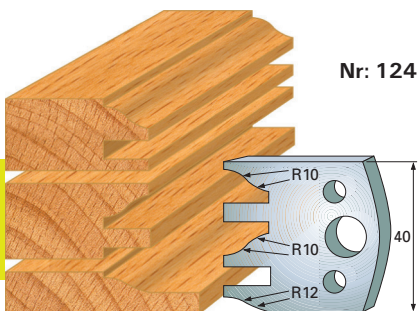

Nr: 124

M 50403124
A 50403324

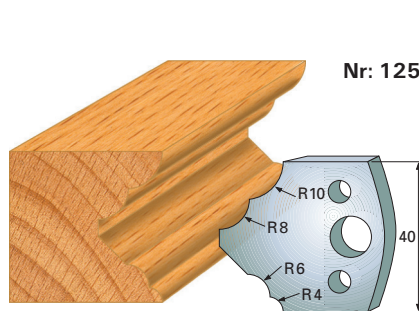

Nr: 125

M 50403125
A 50403325

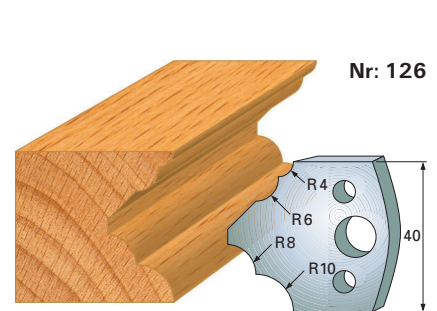

Nr: 126

M 50403126
A 50403326

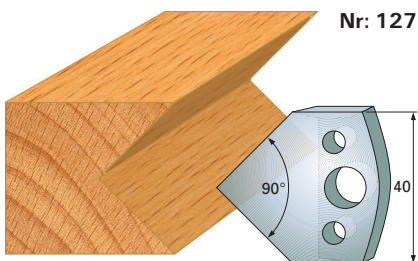

Nr: 127

M 50403127
A 50403327

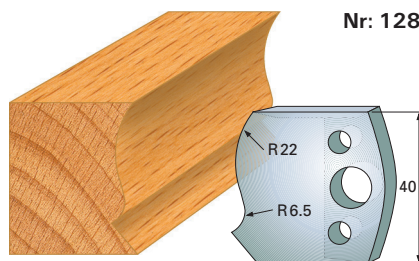

Nr: 128

M 50403128
A 50403328

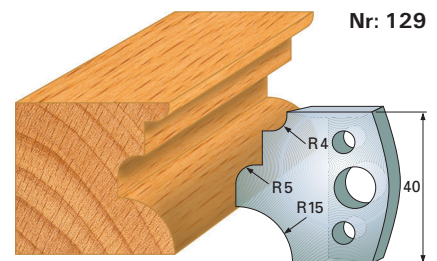

Nr: 129

M 50403129
A 50403329

M = Profile knife A = Deflector *Product discontinued while stocks last

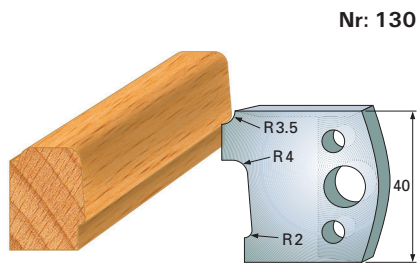

M 50403130
A 50403330

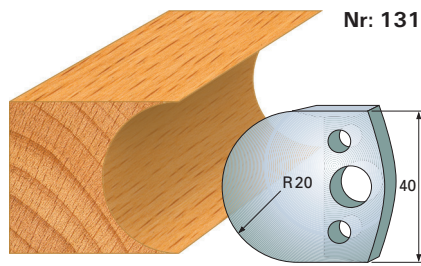

M 50403131
A 50403331

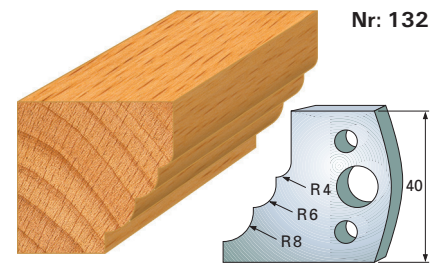

M 50403132
A 50403332

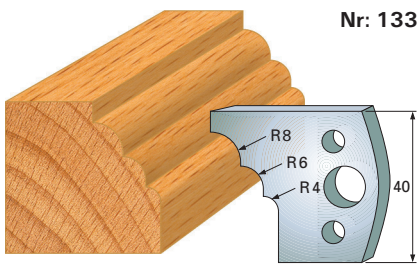

M 50403133
A 50403333

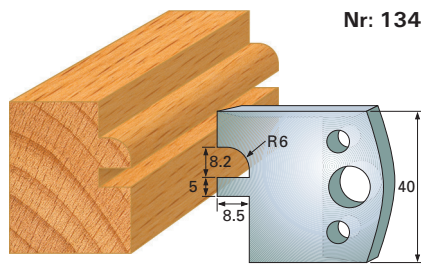

M 50403134
A 50403334

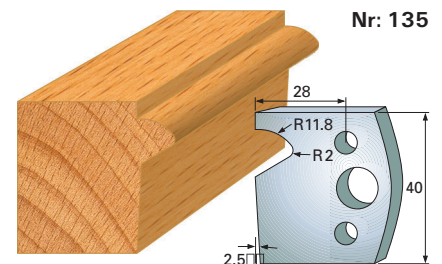

M 50403135
A 50403335

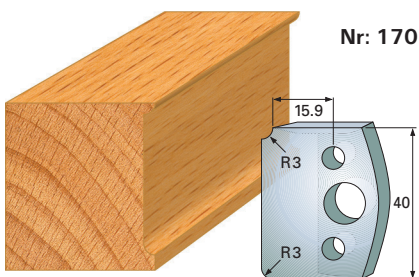

M 50403170
A 50403370

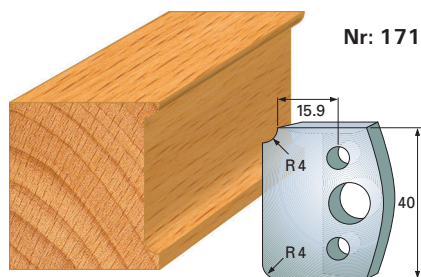

M 50403171
A 50403371

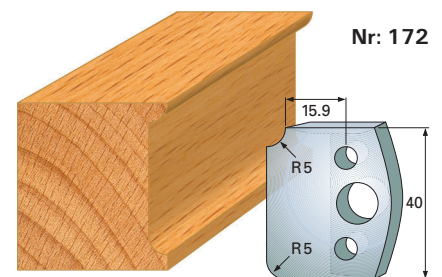

M 50403172
A 50403372

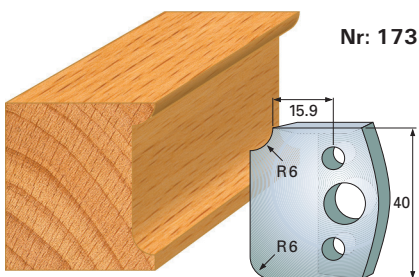

M 50403173
A 50403373

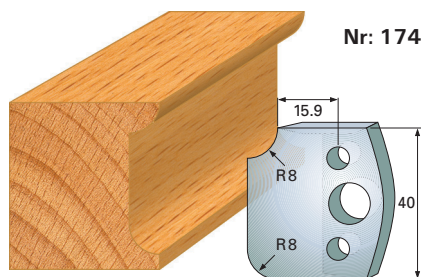

M 50403174
A 50403374

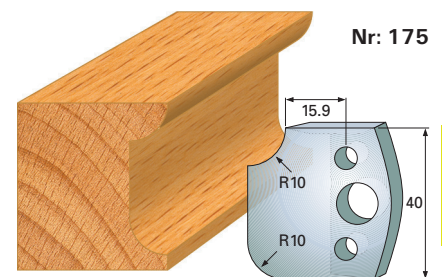

M 50403175
A 50403375

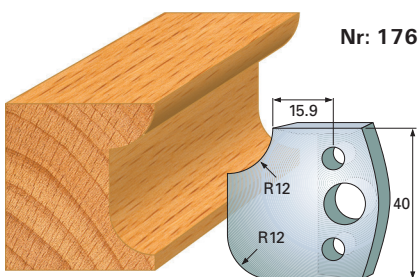

M 50403176
A 50403376

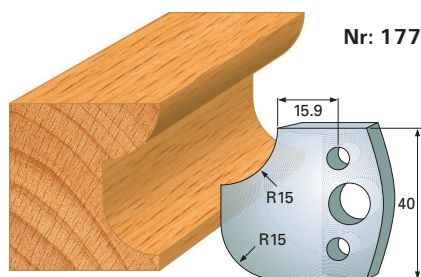

M 50403177
A 50403377

Wood

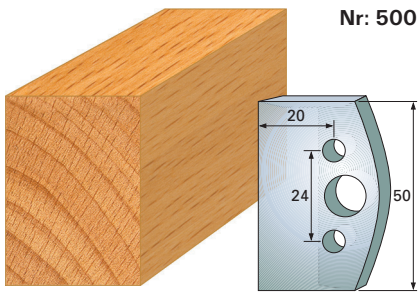

Nr: 500

M 50503000
A 50503200

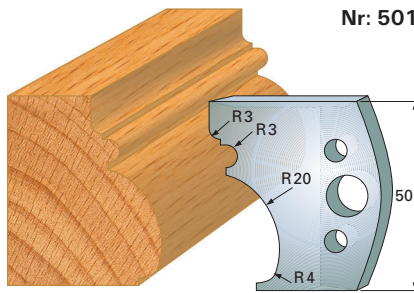

Nr: 501

M 50503001
A 50503201

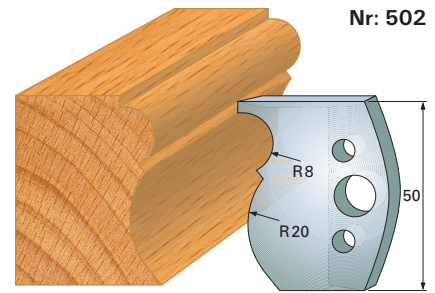

Nr: 502

M 50503002
A 50503202

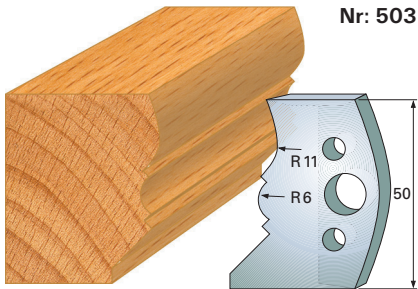

Nr: 503

M 50503003
A 50503203

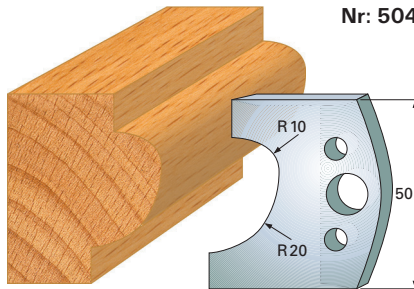

Nr: 504

M 50503004
A 50503204

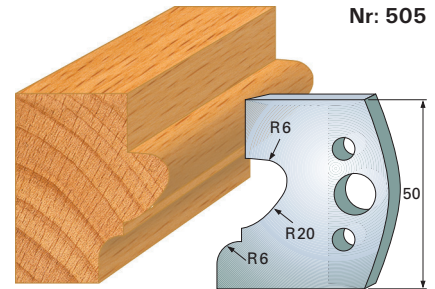

Nr: 505

M 50503005
A 50503205

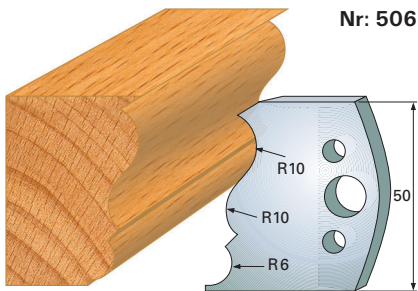

Nr: 506

M 50503006
A 50503206

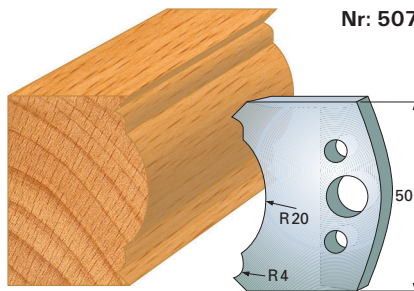

Nr: 507

M 50503007
A 50503207

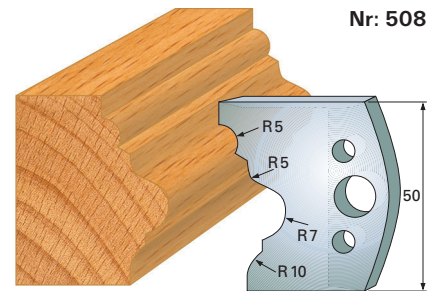

Nr: 508

M 50503008
A 50503208

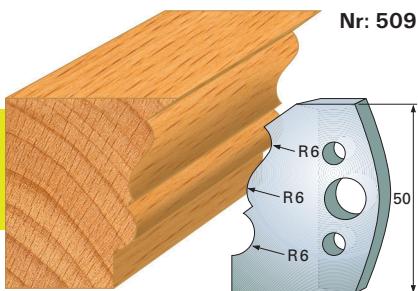

Nr: 509

M 50503009
A 50503209

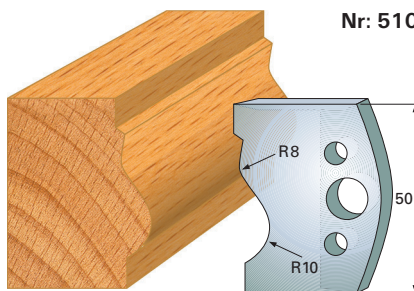

Nr: 510

M 50503010
A 50503210

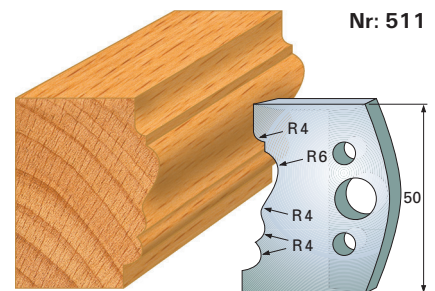

Nr: 511

M 50503011
A 50503211

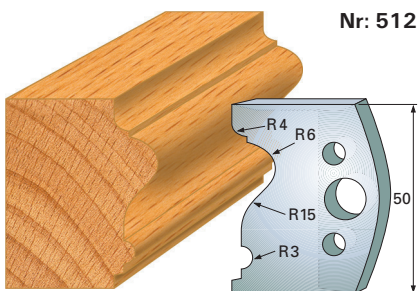

Nr: 512

M 50503012
A 50503212

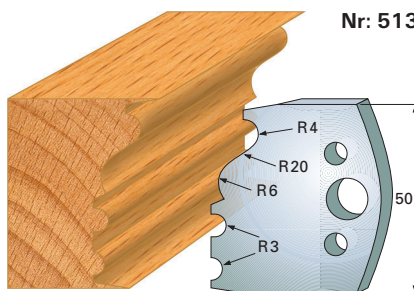

Nr: 513

M 50503013
A 50503213

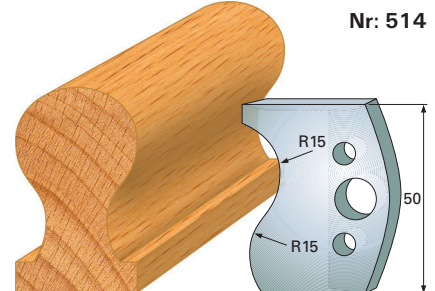

Nr: 514

M 50503014
A 50503214

Wood

M = Profile knife A = Deflector *Product discontinued while stocks last

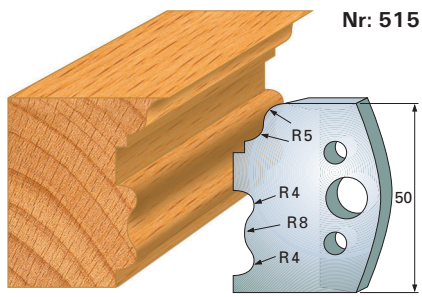

Nr: 515

M 50503015
A 50503215

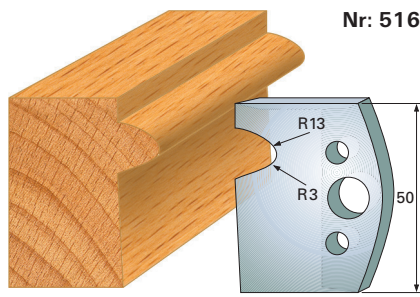

Nr: 516

M 50503016
A 50503216

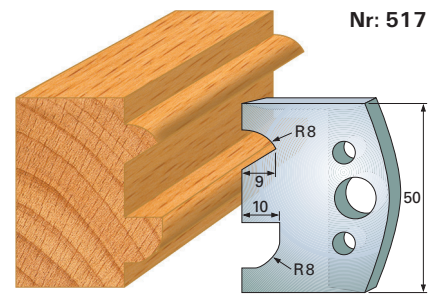

Nr: 517

M 50503017
A 50503217

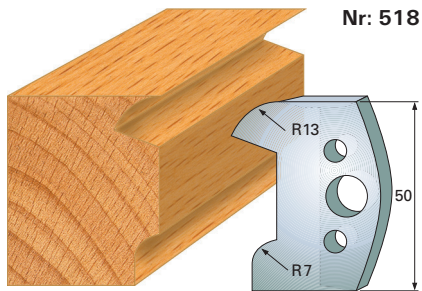

Nr: 518

M 50503018
A 50503218

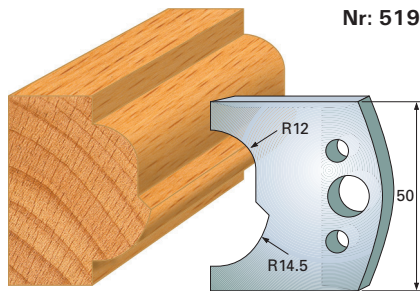

Nr: 519

M 50503019
A 50503219

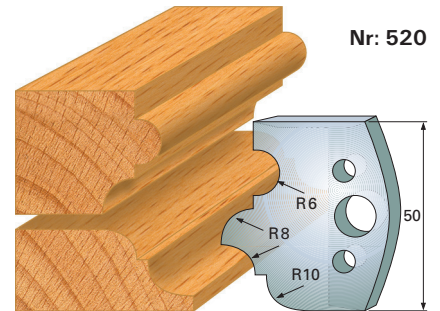

Nr: 520

M 50503020
A 50503220

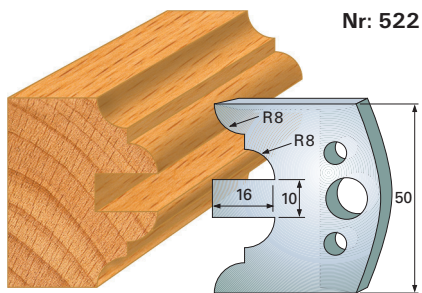

Nr: 522

M 50503022
A 50503222

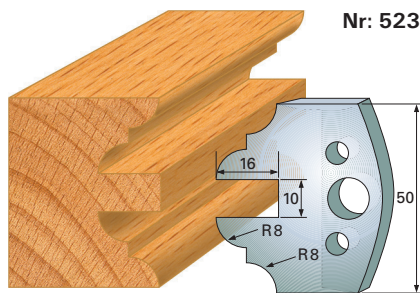

Nr: 523

M 50503023
A 50503223

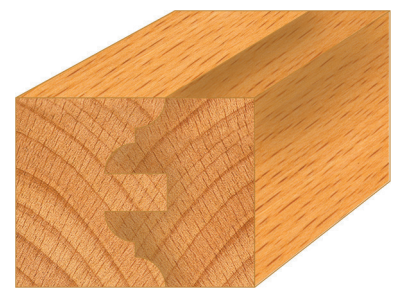

Nr: 524

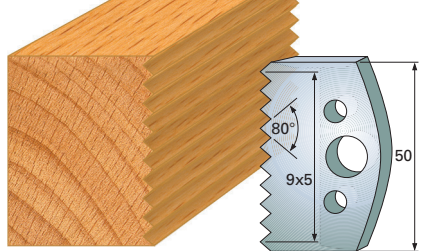

M 50503024
A 50503224

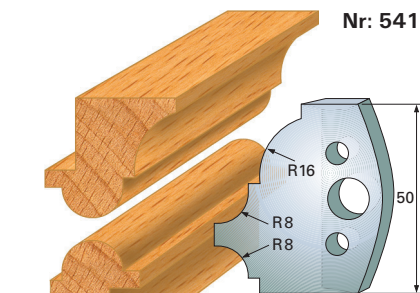

Nr: 541

M 50503041
A 50503241

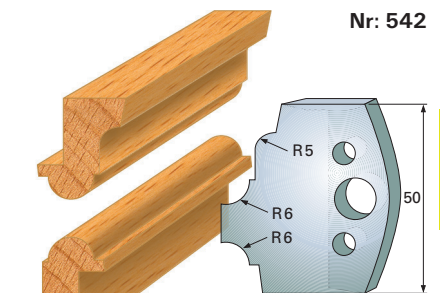

Nr: 542

M 50503042
A 50503242

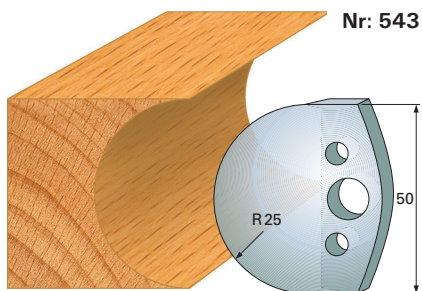

Nr: 543

M 50503043
A 50503243

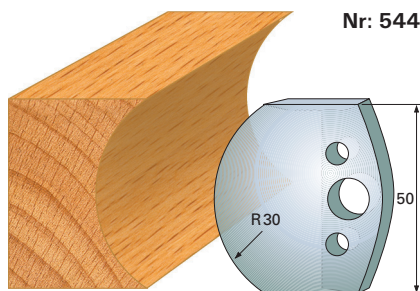

Nr: 544

M 50503044
A 50503244

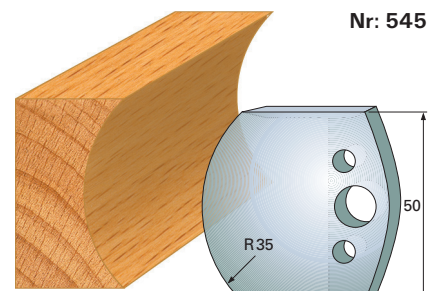

Nr: 545

M 50503045
A 50503245

Wood

M = Profile knife A = Deflector *Product discontinued while stocks last

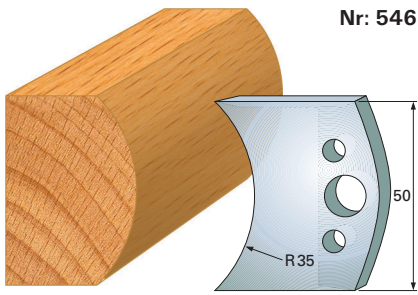

Nr: 546

M 50503046
A 50503246

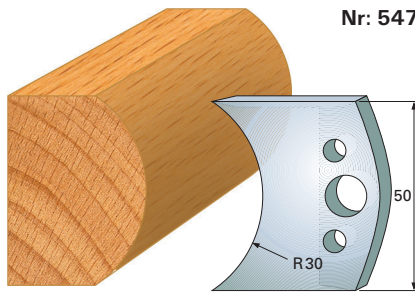

Nr: 547

M 50503047
A 50503247

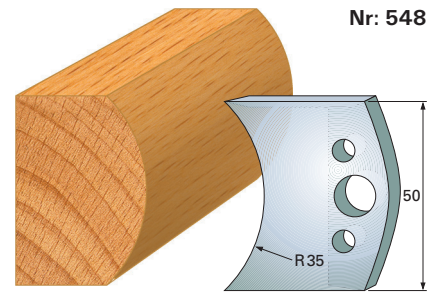

Nr: 548

M 50503048
A 50503248

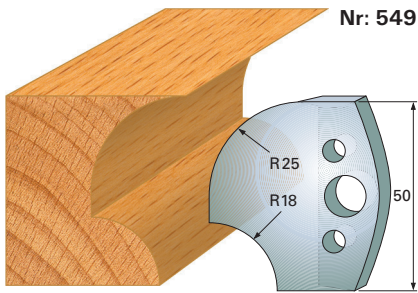

Nr: 549

M 50503049
A 50503249

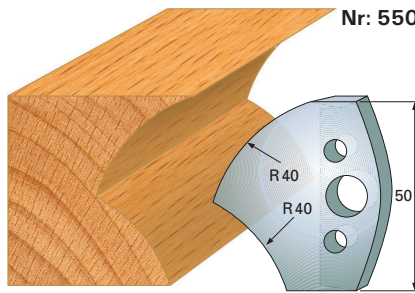

Nr: 550

M 50503050
A 50503250

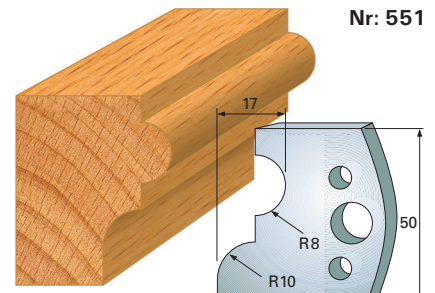

Nr: 551

M 50503051
A 50503251

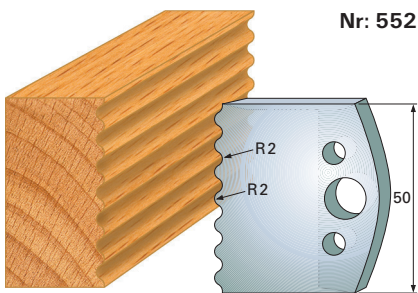

Nr: 552

M 50503052
A 50503252

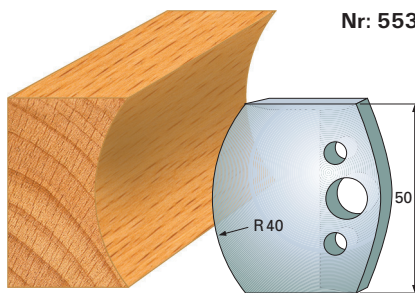

Nr: 553

M 50503053
A 50503253

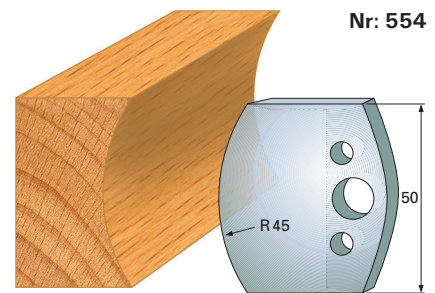

Nr: 554

M 50503054
A 50503254

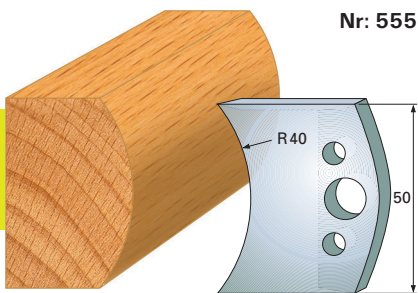

Nr: 555

M 50503055
A 50503255

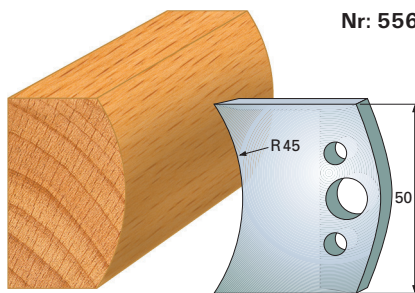

Nr: 556

M 50503056
A 50503256

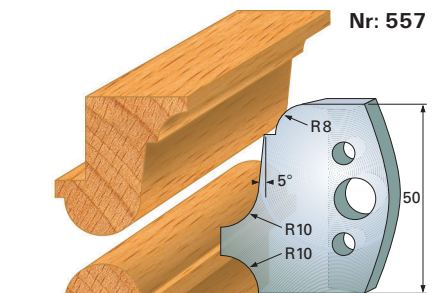

Nr: 557

M 50503057
A 50503257

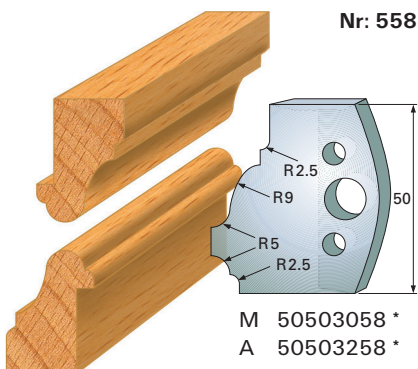

Nr: 558

M 50503058 *
A 50503258 *

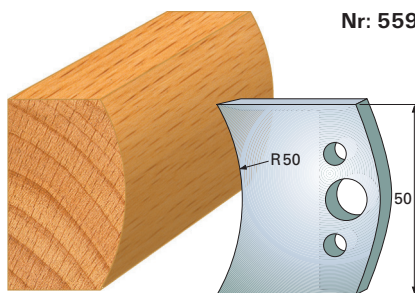

Nr: 559

M 50503059 *
A 50503259 *

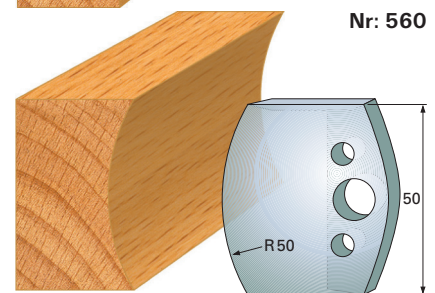

Nr: 560

M 50503060 *
A 50503260 *

M = Profile knife A = Deflector *Product discontinued while stocks last

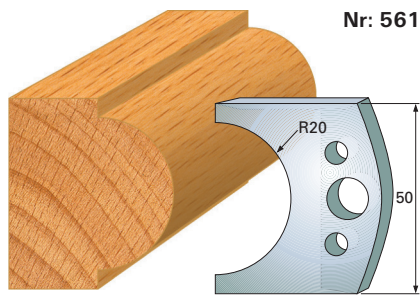

Nr: 561

M 50503061 * vervallen
A 50503261 * vervallen

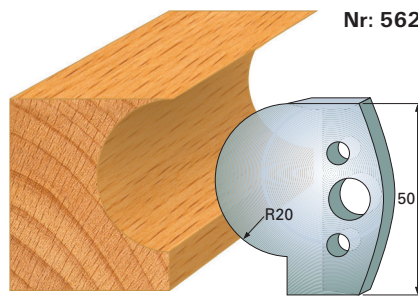

Nr: 562

M 50503062 *
A 50503262 *

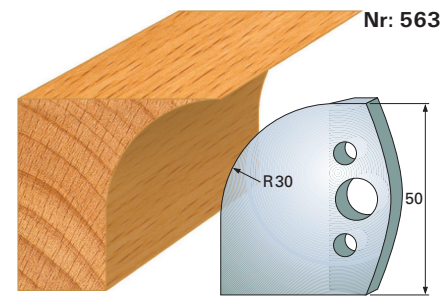

Nr: 563

M 50503063 *
A 50503263 *

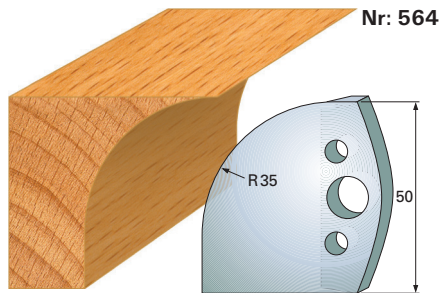

Nr: 564

M 50503064 *
A 50503264 *

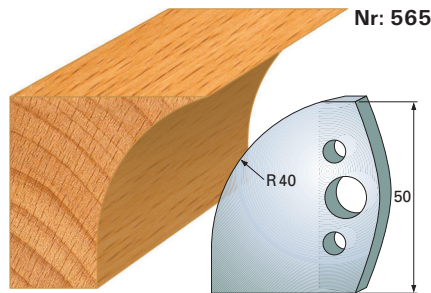

Nr: 565

M 50503065 *
A 50503265 *

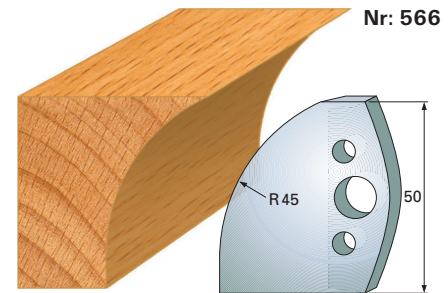

Nr: 566

M 50503066 *
A 50503266 *

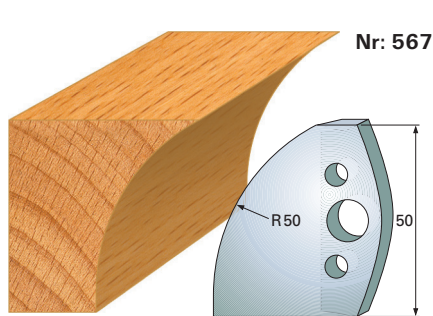

Nr: 567

M 50503067 *
A 50503267 *

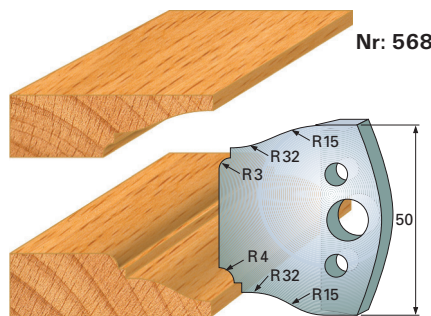

Nr: 568

M 50503068 *
A 50503268 *

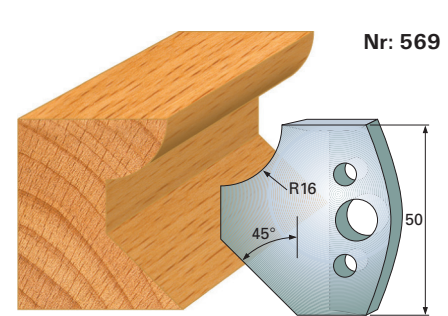

Nr: 569

M 50503069 *
A 50503269 *

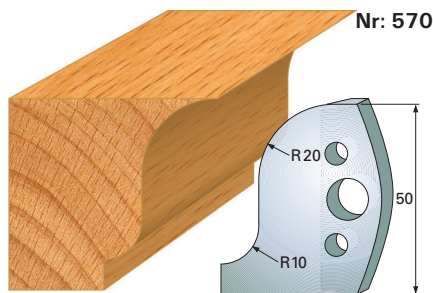

Nr: 570

M 50503070 *
A 50503270 *

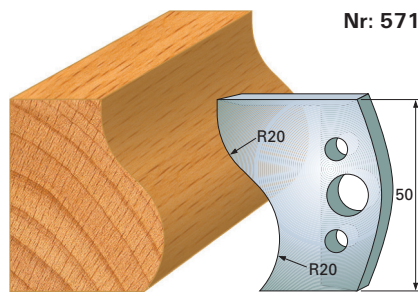

Nr: 571

M 50503071 *
A 50503271 *

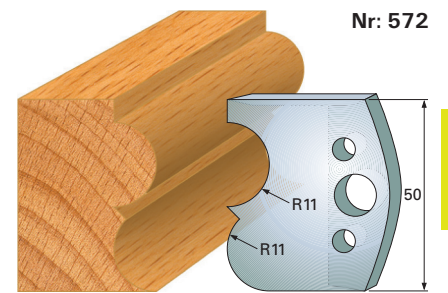

Nr: 572

M 50503072 *
A 50503272 *

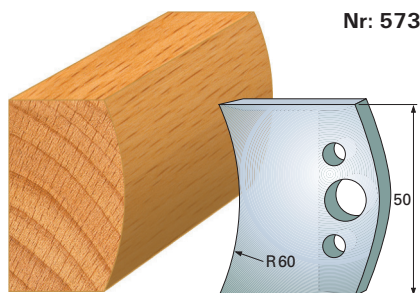

Nr: 573

M 50503073 *
A 50503273 *

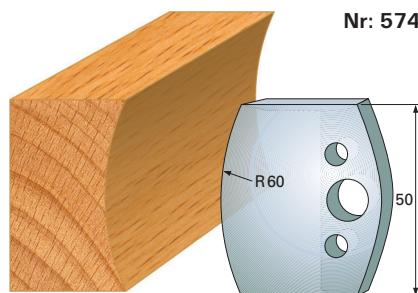

Nr: 574

M 50503074 *
A 50503274 *

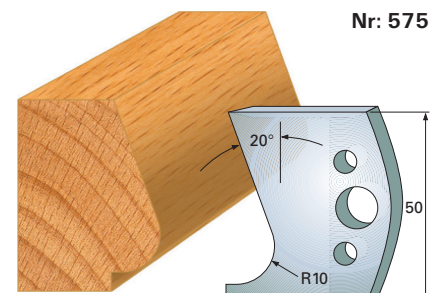

Nr: 575

M 50503075 *
A 50503275 *

Wood

M = Profile knife A = Deflector *Product discontinued while stocks last

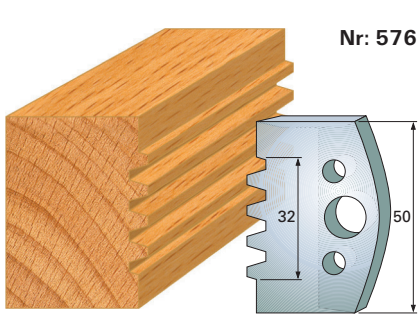

Nr: 576

M 50503076 *
A 50503276 *

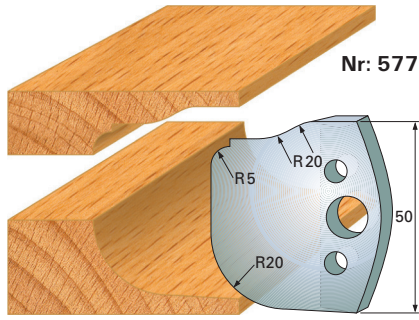

Nr: 577

M 50503077 *
A 50503277 *

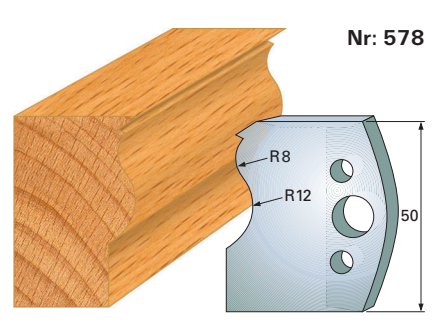

Nr: 578

M 50503078 *
A 50503278 *

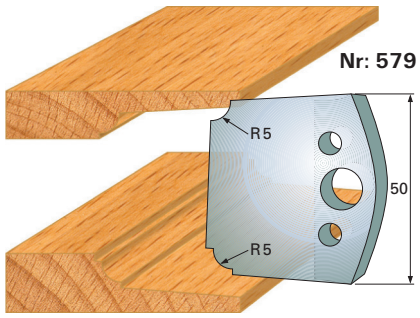

Nr: 579

M 50503079 *
A 50503279 *

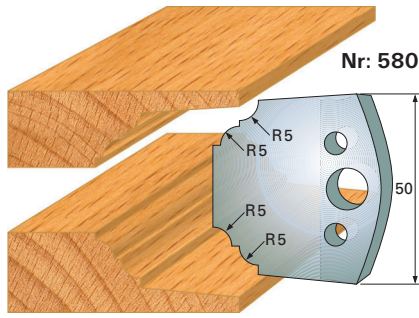

Nr: 580

M 50503080 *
A 50503280 *

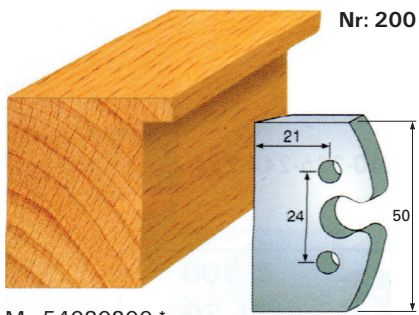

M 54030200 *
A 54032200 *

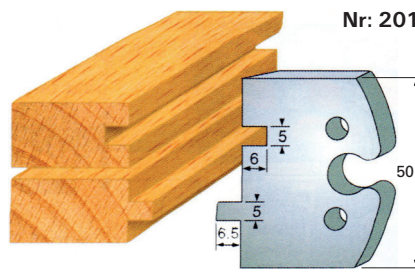

M 54030201 *
A 54032201 *

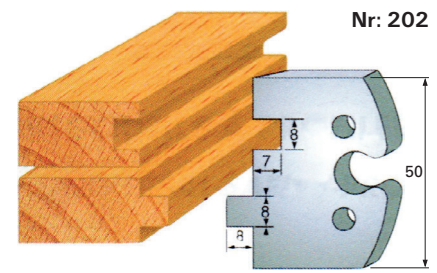

M 54030202 *
A 54032202 *

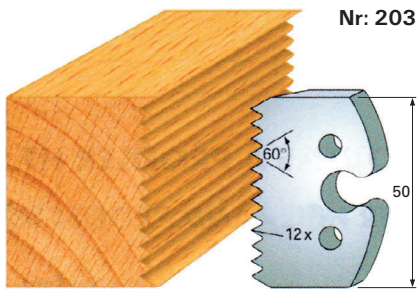

M 54030203 *
A 54032203 *

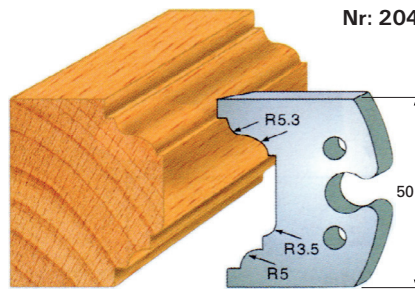

M 54030204 *
A 54032204 *

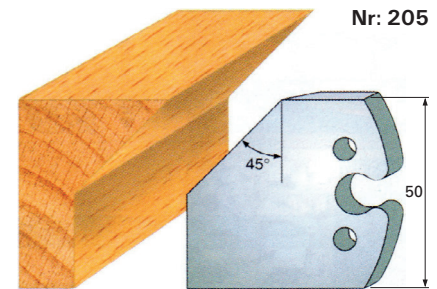

M 54030205 *
A 54032205 *

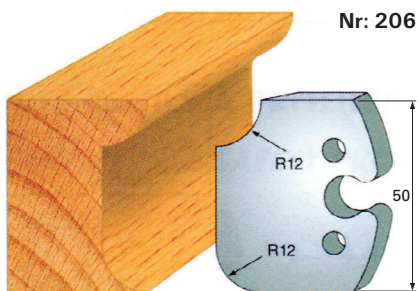

M 54030206 *
A 54032206 *

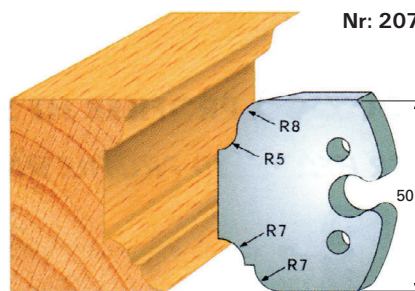

M 54030207 *
A 54032207 *

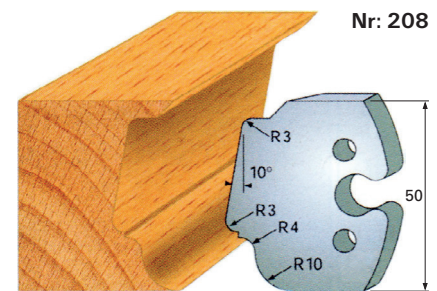

M 54030208 *
A 54032208 *

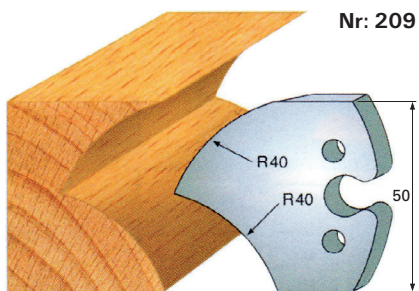

M 54030209 *
A 54032209 *

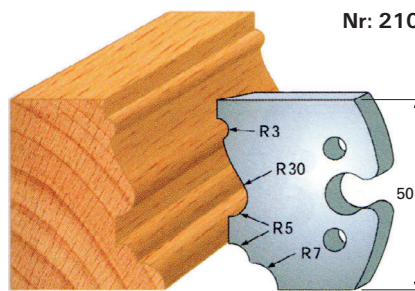

M 54030210 *
A 54032210 *

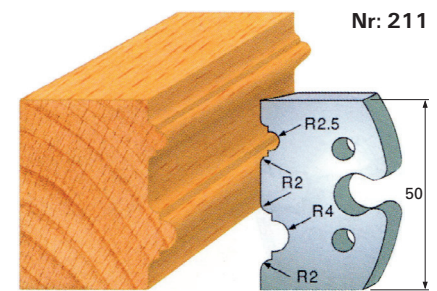

M 54030211 *
A 54032211 *

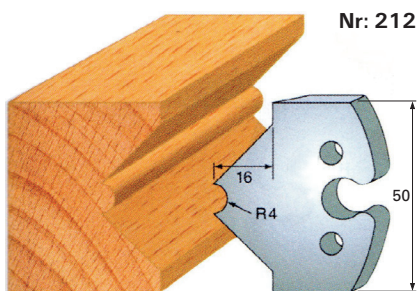

M 54030212 *
A 54032212 *

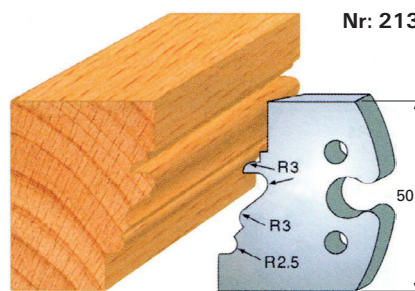

M 54030213 *
A 54032213 *

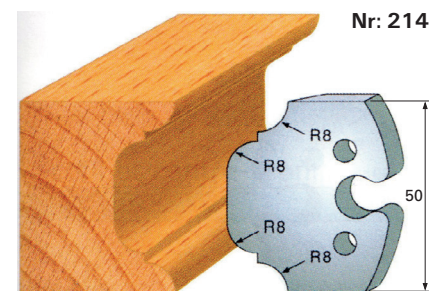

M 54030214 *
A 54032214 *

Wood

M = Profile knife A = Deflector *Product discontinued while stocks last

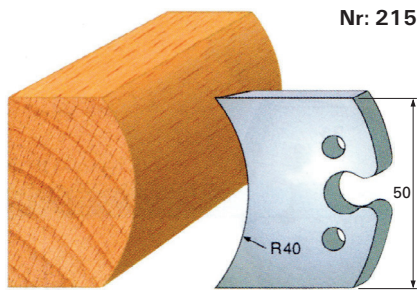

Nr: 215

M 54030215 *
A 54032215 *

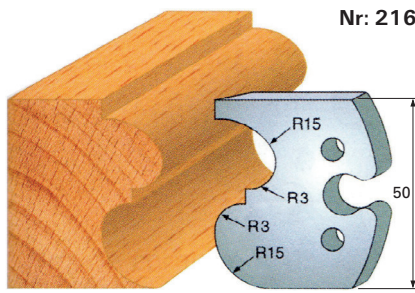

Nr: 216

M 54030216 *
A 54032216 *

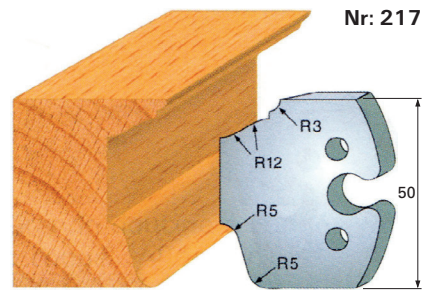

Nr: 217

M 54030217 *
A 54032217 *

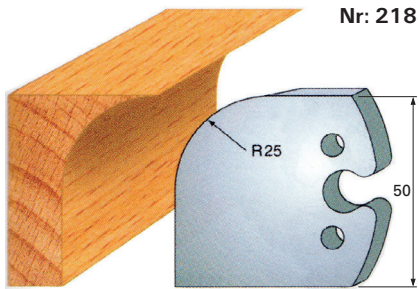

Nr: 218

M 54030218 *
A 54032218 *

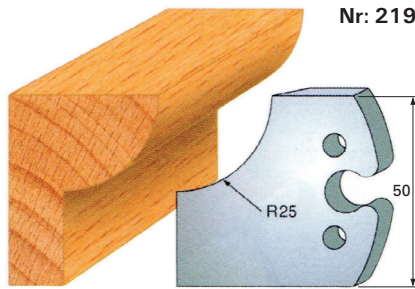

Nr: 219

M 54030219 *
A 54032219 *

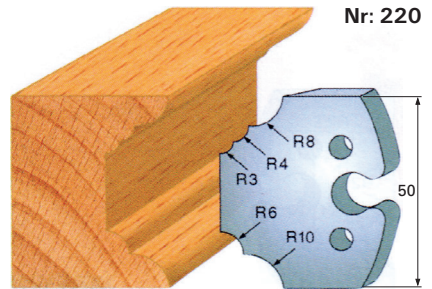

Nr: 220

M 54030220 *
A 54032220 *

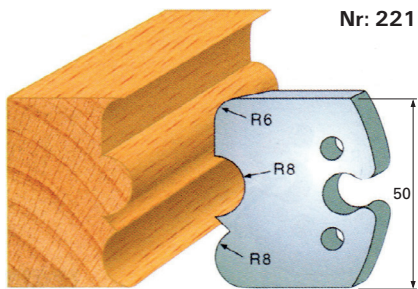

Nr: 221

M 54030221 *
A 54032221 *

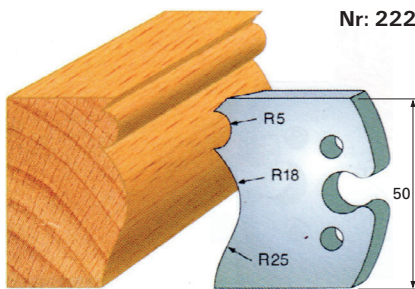

Nr: 222

M 54030222 *
A 54032222 *

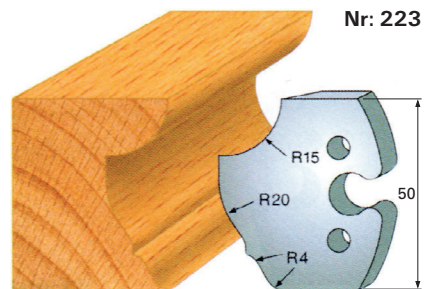

Nr: 223

M 54030223 *
A 54032223 *

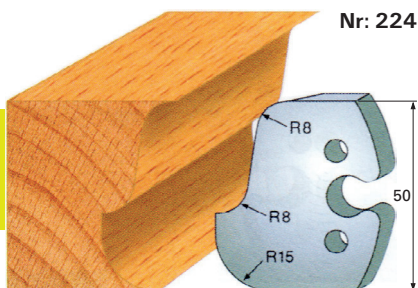

Nr: 224

M 54030224 *
A 54032224 *

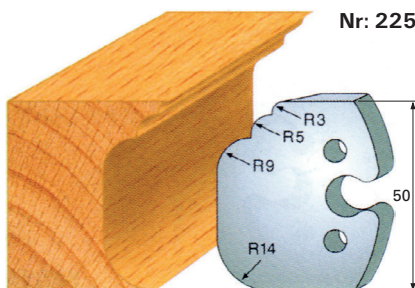

Nr: 225

M 54030225 *
A 54032225 *

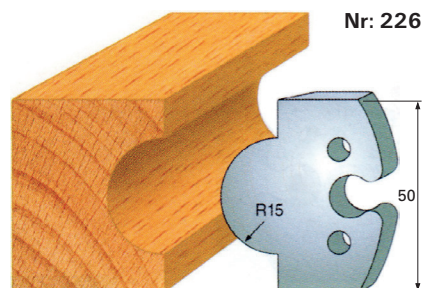

Nr: 226

M 54030226 *
A 54032226 *

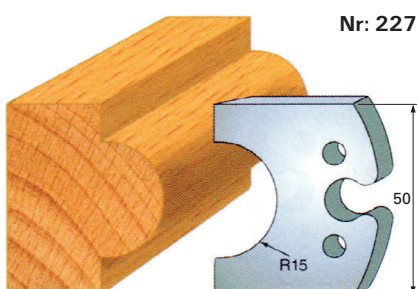

Nr: 227

M 54030227 *
A 54032227 *

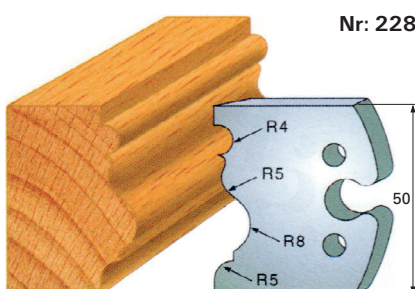

Nr: 228

M 54030228 *
A 54032228 *

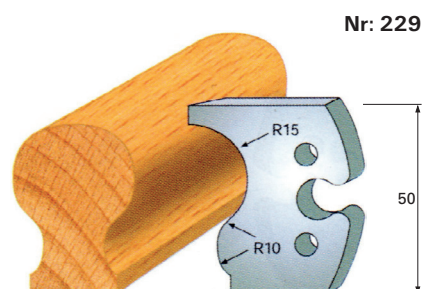

Nr: 229

M 54030229 *
A 54032229 *

M = Profile knife A = Deflector *Product discontinued while stocks last

Wood

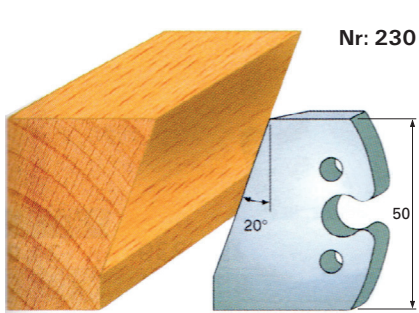

Nr: 230

M 54030230 *
A 54032230 *

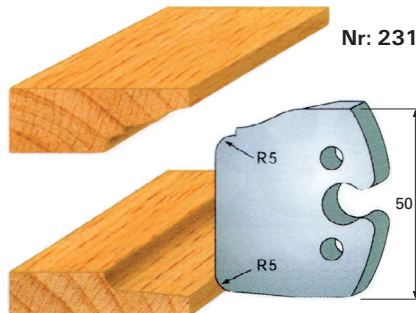

Nr: 231

M 54030231 *
A 54032231 *

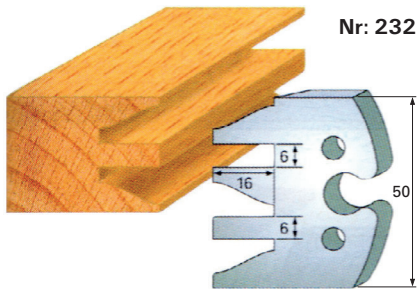

Nr: 232

M 54030232 *
A 54032232 *

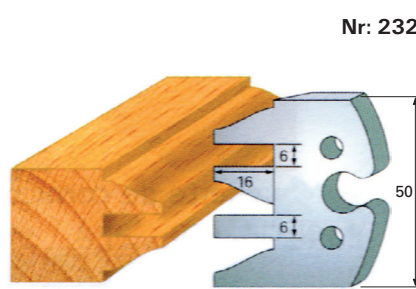

Nr: 232

M 54030232 *
A 54032232 *

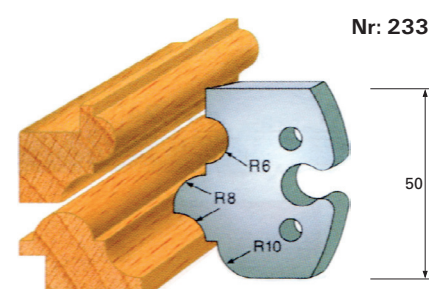

Nr: 233

M 54030233 *
A 54032233 *

HSS Knife blanks

PU = 6

Product

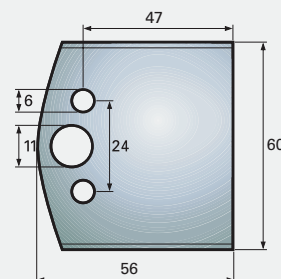
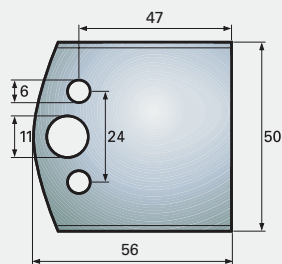
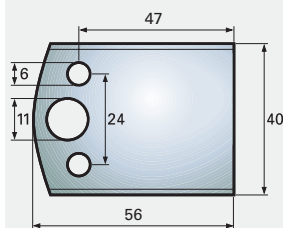
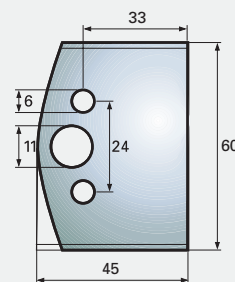
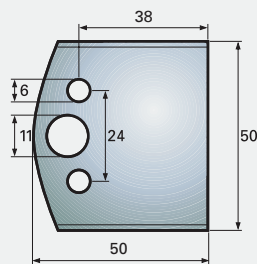
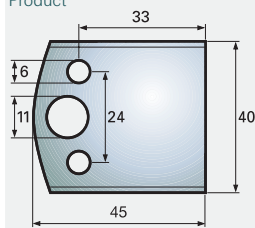

B= 40 mm

B= 50 mm

B= 60 mm

Notes

- **Attention!**
- On our Silverline cutterheads, the knives must be ground back from 59 mm to 56 mm (due to assembly MAN standard).

Product features					Order information	
B [mm]	L [mm]	d [mm]	profile depth (T) max [mm]		PU [pc.]	Order-No
40	45	4	19	HSS	6	40304045
40	59/56	4	30	HSS	6	40304059
50	50	4	24	HSS	6	40305050 *
50	59/56	4	30	HSS	6	40305059
60	45	4	19	HSS	6	40306045 *
60	59/56	4	30	HSS	6	40306059

M = Profile knife A = Deflector *Product discontinued while stocks last



Your authorized dealer:

